



STEEL STAR
www.greatforming.com



Over 15 Years Roll Forming Machine Of Experience



Clear Plans Clear Prices. Make The Best Plan For You

Roll Forming Machine

CANGZHOU STEELSTAR MACHINERY CO.,LTD.

Contents



Company Profile



Foreign Partners



Exhibitions



STEEL STAR
www.greatforming.com



Product Catalog

1. Roof Sheet Roll Forming Machine
2. Light Keel Stud And Track Roll Forming Machine
3. Shutter Door Roll Forming Machine
4. C/Z Purlin Roll Forming Machine
5. Ridge Cap Roll Forming Machine
6. Barrel Corrugated Roll Forming Machine
7. Floor Deck Roll Forming Machine
8. Car Board Roll Forming Machine
9. Rain Gutter / Downspouts Roll Forming Machine



STEEL STAR
www.greatforming.com



Product Catalog

10. Light Keel Villa Frame Roll Forming Machine
11. Guardrail Plate Roll Forming Machine
12. EPS Foam/Rock Wool Roof Sheet Composite Production Line
13. (PU) Polyurethane Sandwich Panel Production Line
14. Decoiler / Auto Stacker Roof Panel Machine
15. Bending / Guillotine Shearing Machine
16. Steel Coil Slitting Line Machine
17. Solar Bracket Machine
18. Steel Pipe Making Machine



STEEL STAR
www.greatforming.com



Product Catalog

19. Racking Roll Forming Machine
20. Cable Tray Roll Forming Machine
21. Metal Embossing Line
22. Fence Post / Picket Fence Roll Forming Machine
23. Silo Roll Forming Machine
24. Foot Pedal Roll Forming Machine
25. Standing Seam Roll Forming Machine
26. Stone Coated Roof Tile Making Machine
27. Various Products Can Be Customized

Contents



Shipping Abroad



Service



Contact Us



STEEL STAR
www.greatforming.com

Company Profile

**The factory covers an area
of 20000m²**

Real production factory

24 hours online service

**15 years of industry
experience**

**Cooperated with more
than 30 countries**

Clear Plans Clear Prices

**German copra design
software**

**Has many foreign
partners**

**Obtained multiple
international certifications**



STEEL STAR
www.greatforming.com

Company Factory View

Factory Area



Raw Material Machining Workshop



Assembly Production Workshop





STEEL STAR
www.greatforming.com

Company Honor Certificate





STEEL STAR
www.greatforming.com

Foreign Partners





STEEL STAR
www.greatforming.com

Exhibitions

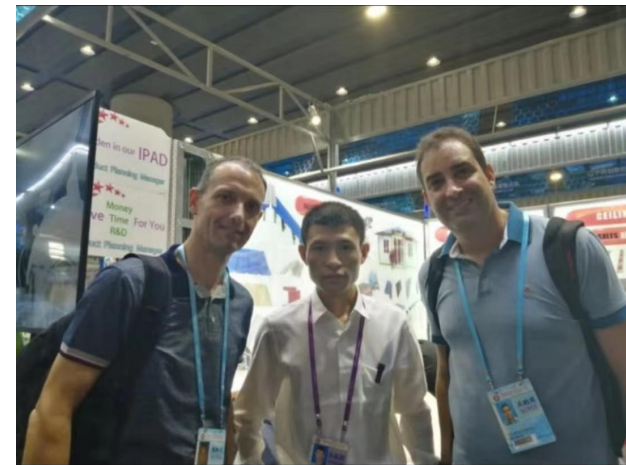
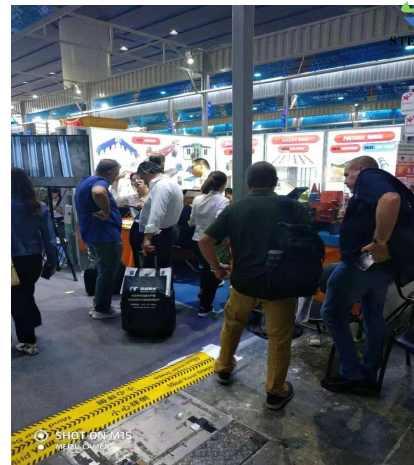
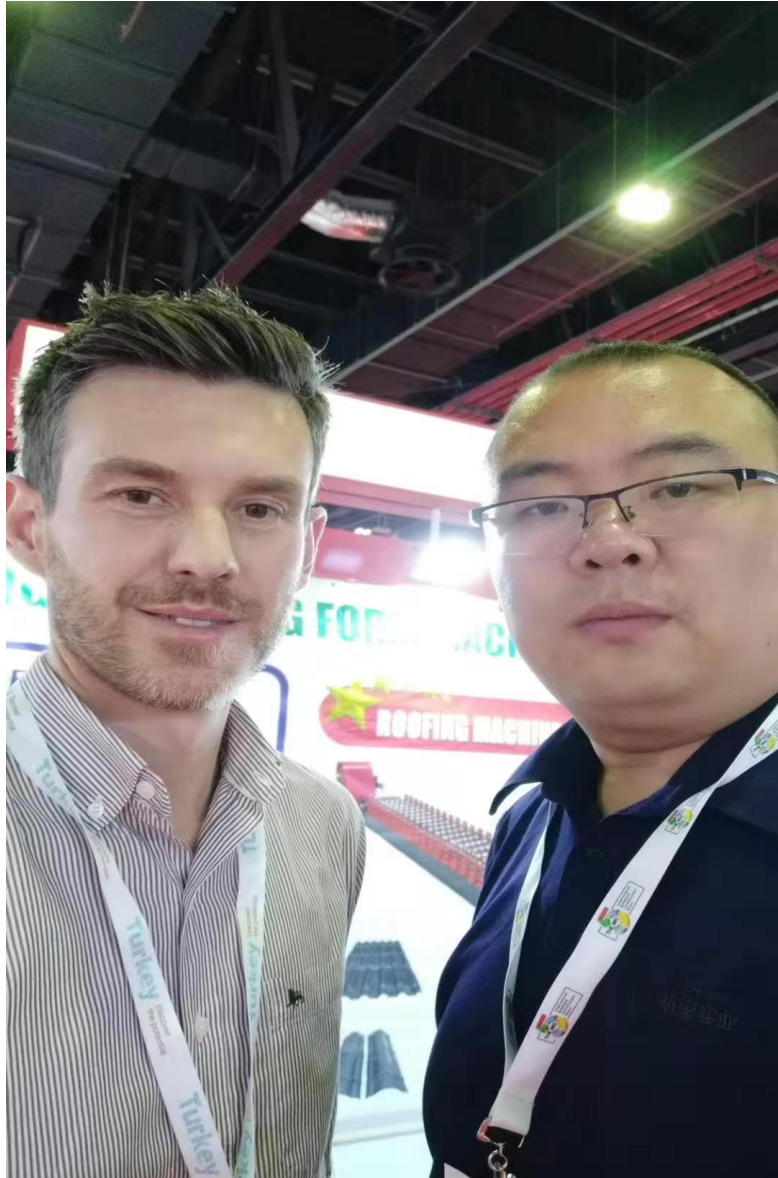



STEEL STAR
www.greatforming.com

Product Catalog

1. Roof Sheet Roll Forming Machine

1-1 Single Model Trapezoidal Roof Sheet Roll Forming Machine

Application Scenarios

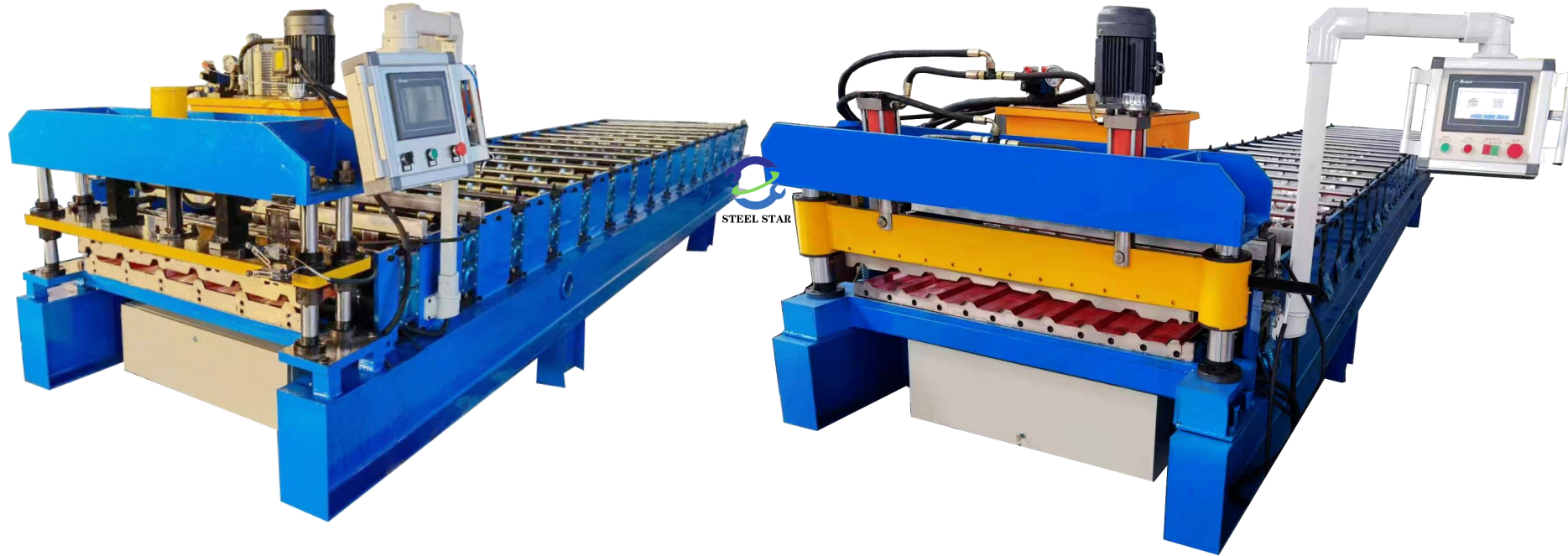



STEEL STAR
www.greatforming.com

1-1 Single Model Trapezoidal Roof Sheet Roll Forming Machine

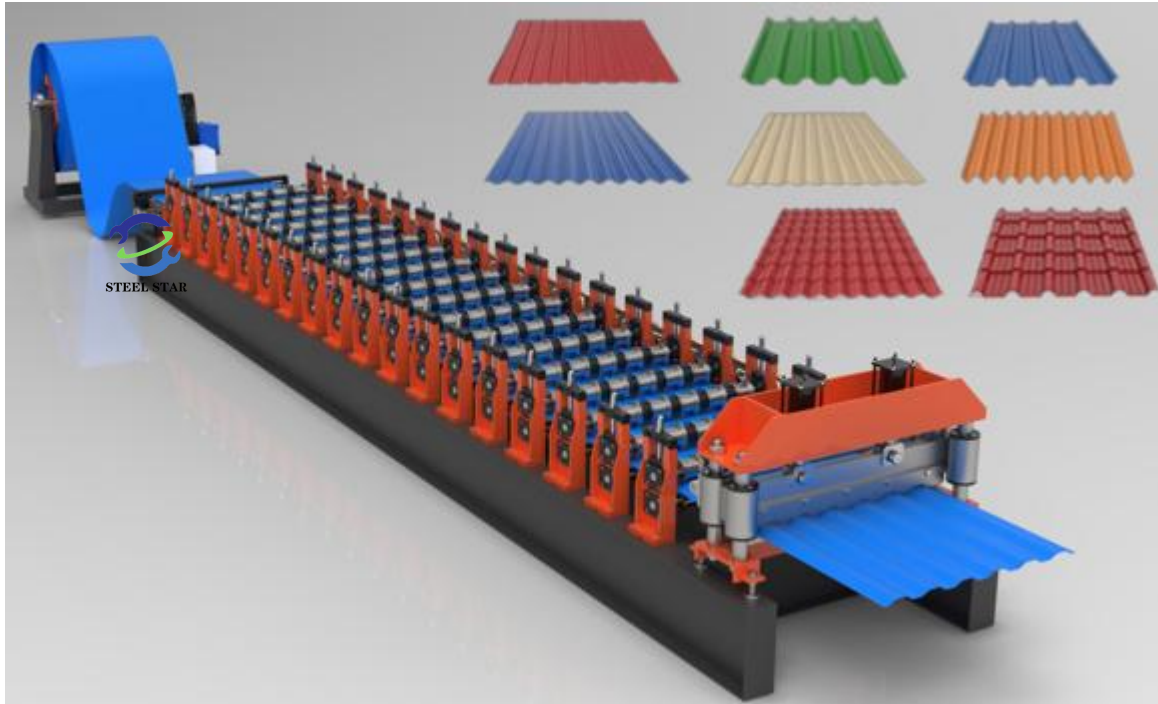

Trapezoidal roofing sheet

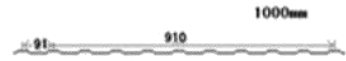

YX 6-91-910

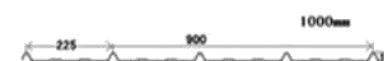

YX 15-225-900



YX 22-213-860

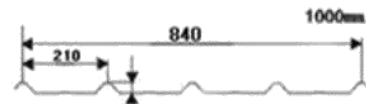

YX 25-210-840

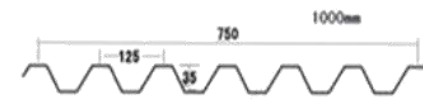

YX 35-130125-750

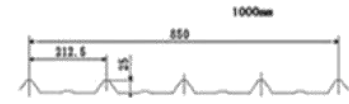

YX 25-212.5-850

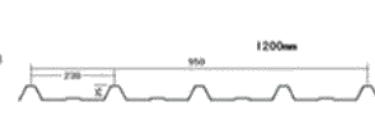
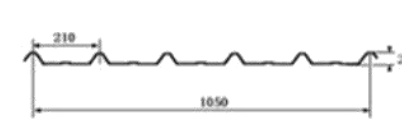
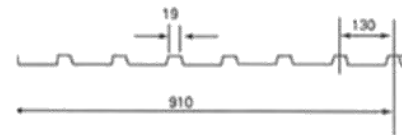



Product Catalog

1. Roof Sheet Roll Forming Machine

STEEL STAR
www.greatforming.com

1-2 Single Model Corrugated Roof Sheet Roll Forming Machine

Application Scenarios

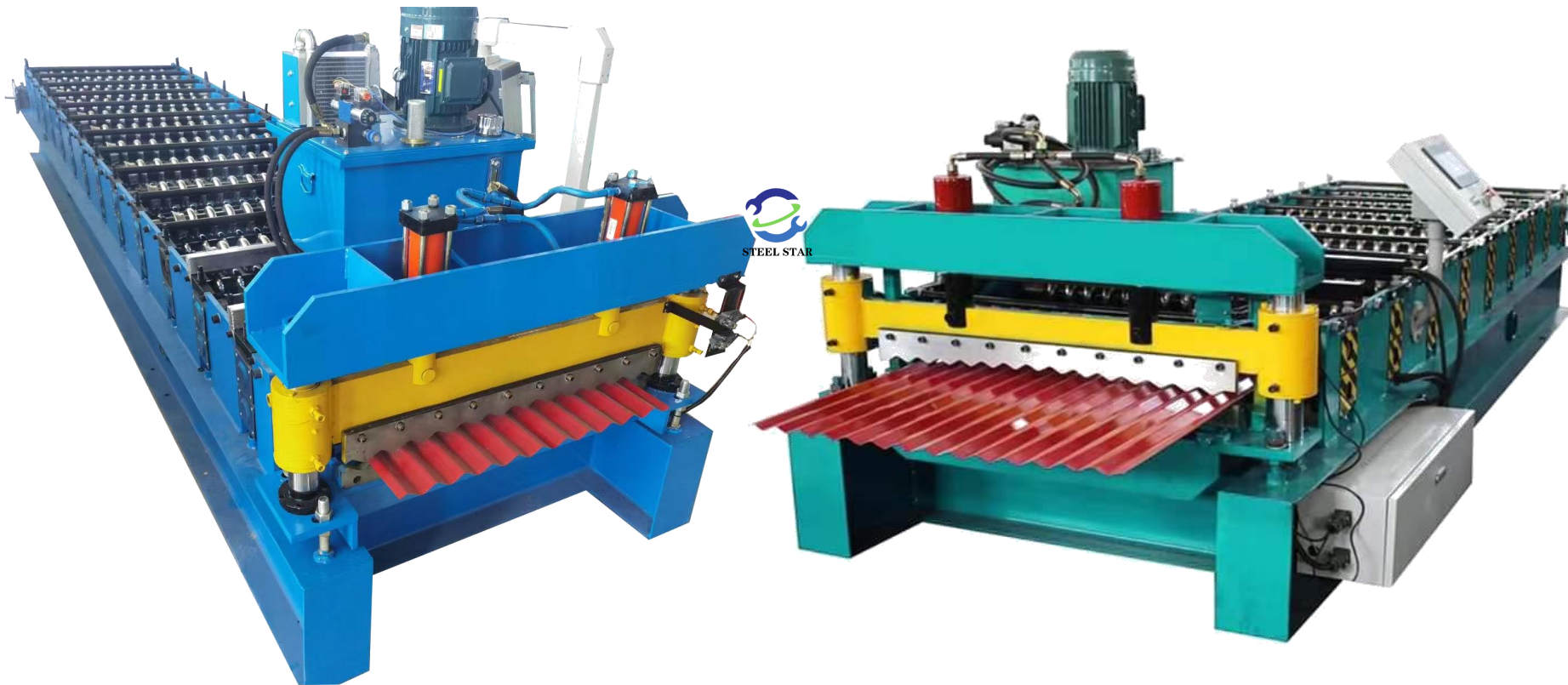



1-2 Single Model Corrugated Roof Sheet Roll Forming Machine

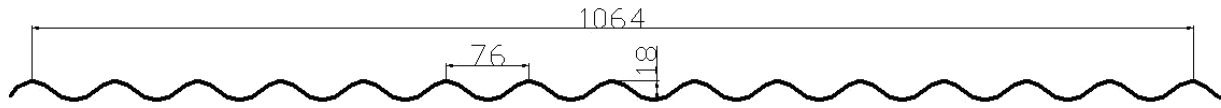

进料宽度: 1250mm

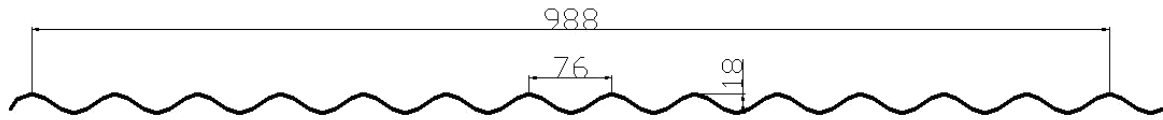

进料宽度: 1200mm

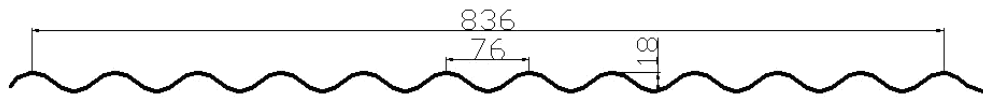

进料宽度: 1000mm

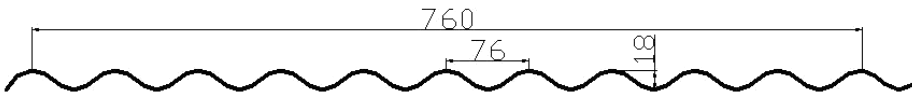

进料宽度: 940mm

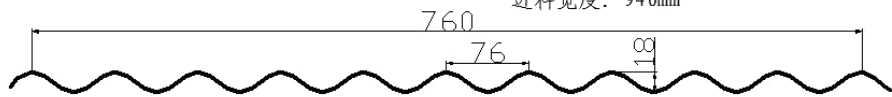

进料宽度: 914mm

Wave roofing sheet

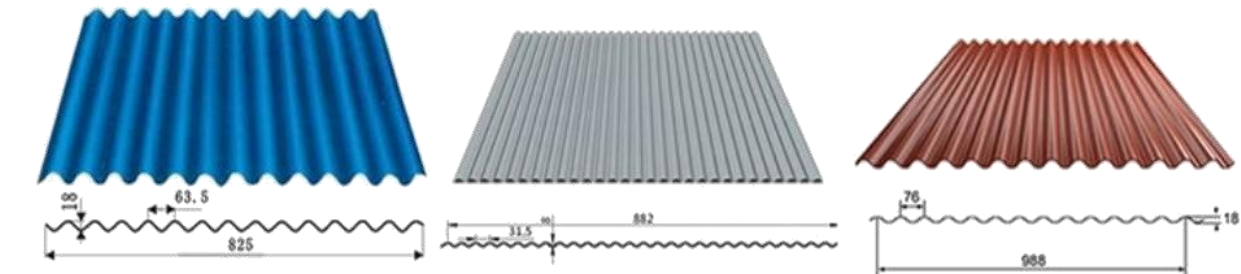

YX 18-63.5-825

YX 8-31.5-882

YX 18-76-988

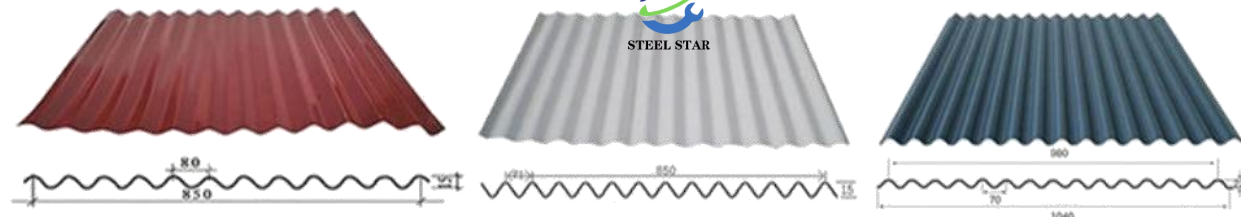

YX 15-80-850

YX 15-71-850

YX 22-70-980

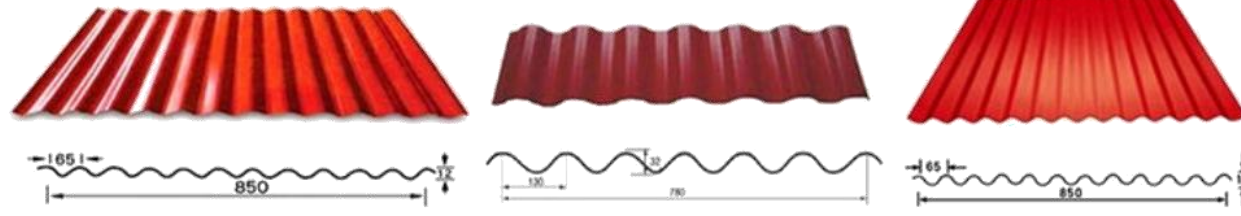

YX 12-65-850

YS 32-130-780

YS 13-65-850



STEEL STAR
www.greatforming.com

Product Catalog

1. Roof Sheet Roll Forming Machine

1-3 Single Model Glazed Tile Roof Sheet Roll Forming Machine

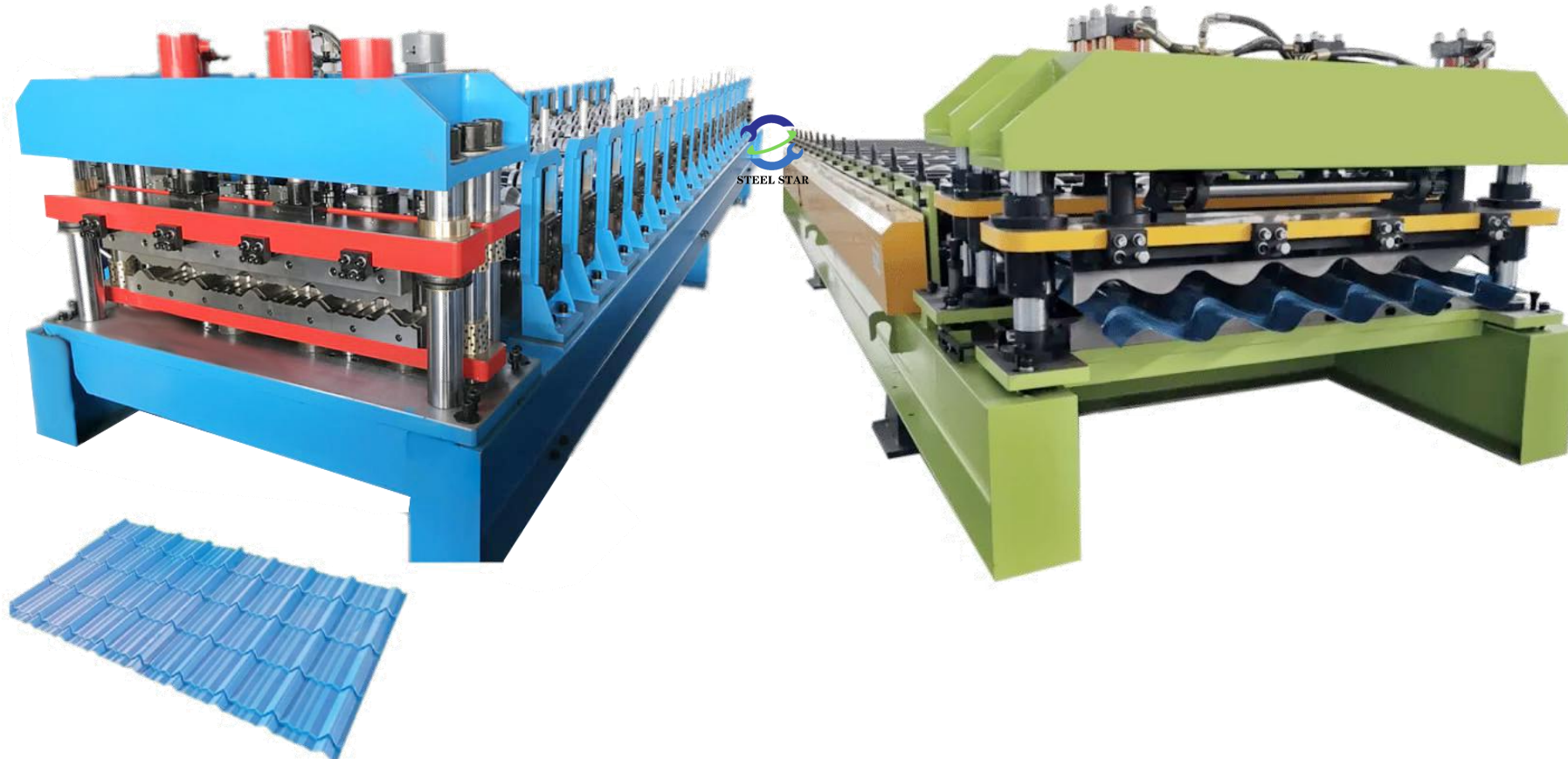

Application Scenarios





STEEL STAR
www.greatforming.com

Product Catalog

1. Roof Sheet Roll Forming Machine

1-3 Single Model Glazed Tile Roof Sheet Roll Forming Machine



Glazed roofing sheet

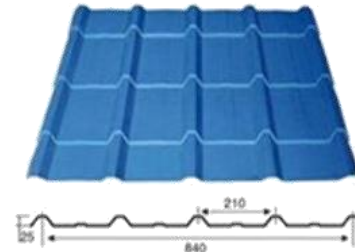

YX 25-210-840

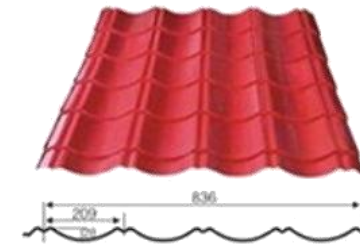

YX 28-29-836

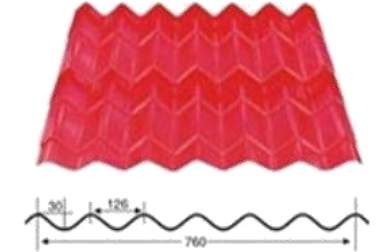

YX 30-126-760

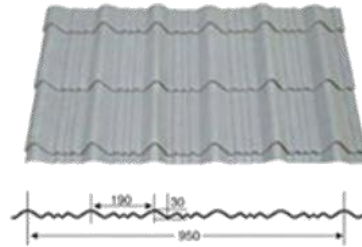

YX 30-190-950

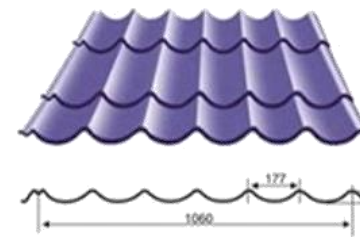

YX 30-177-1060

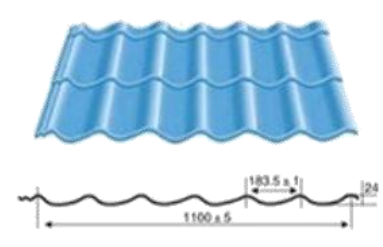

YX 24-183.5-1100

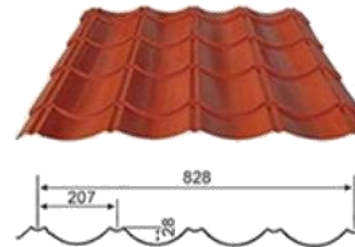

YX 28-207-828

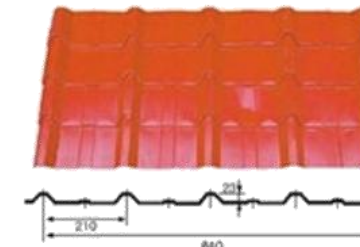

YX 28-207-828

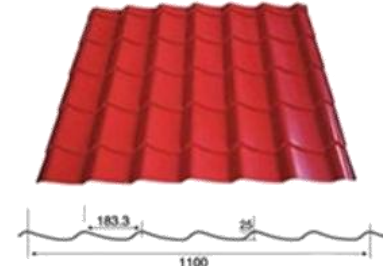

YX 25-183.3-1100



Product Catalog

1. Roof Sheet Roll Forming Machine

STEEL STAR
www.greatforming.com

1-4 Double Layer/Double Models Roof Sheet Roll Forming Machine

Application Scenarios

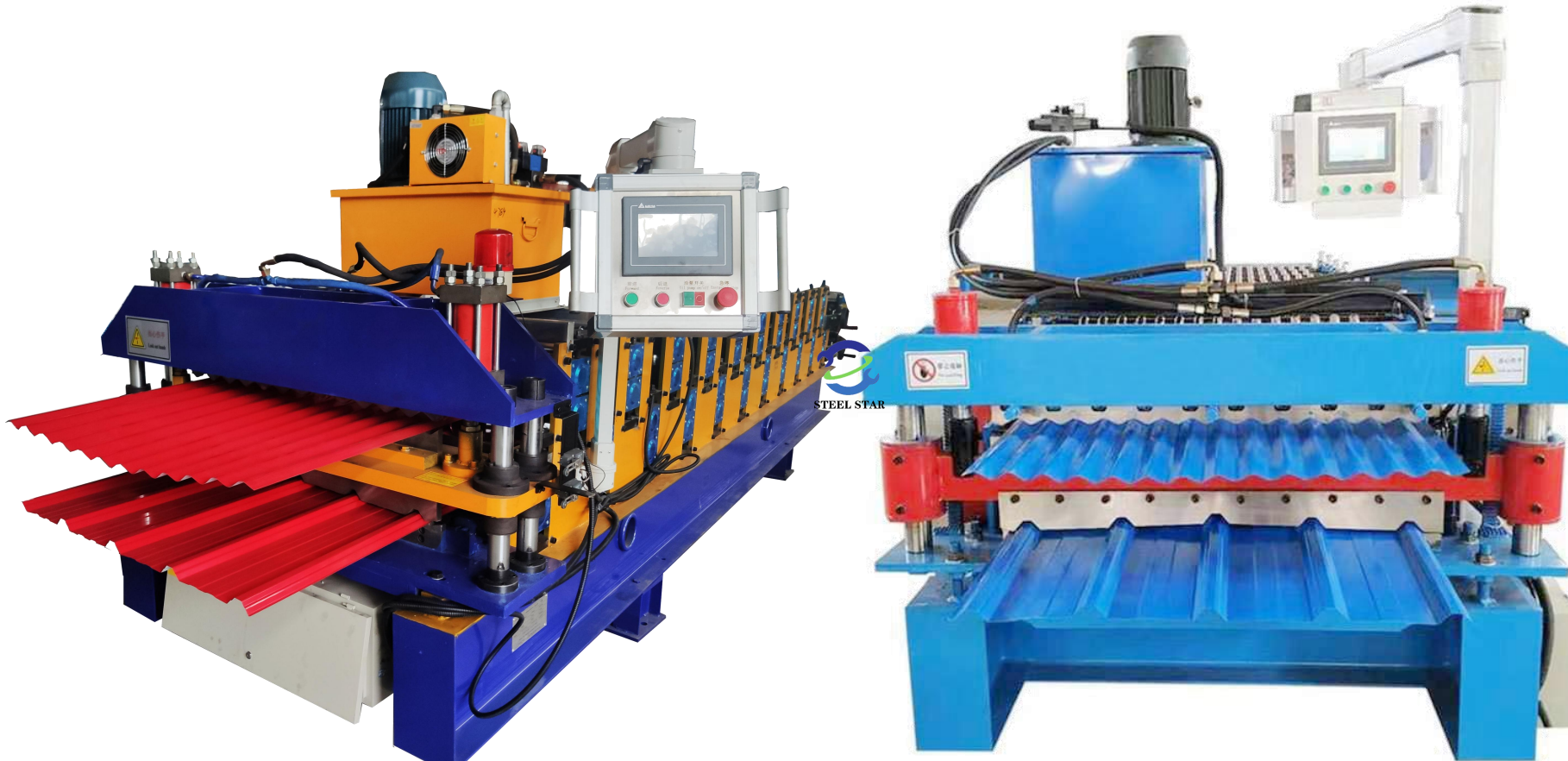



STEEL STAR
www.greatforming.com

Product Catalog

1. Roof Sheet Roll Forming Machine

1-5 Double Layer/Double Models Glazed Tile Roof Sheet Roll Forming Machine

Application Scenarios

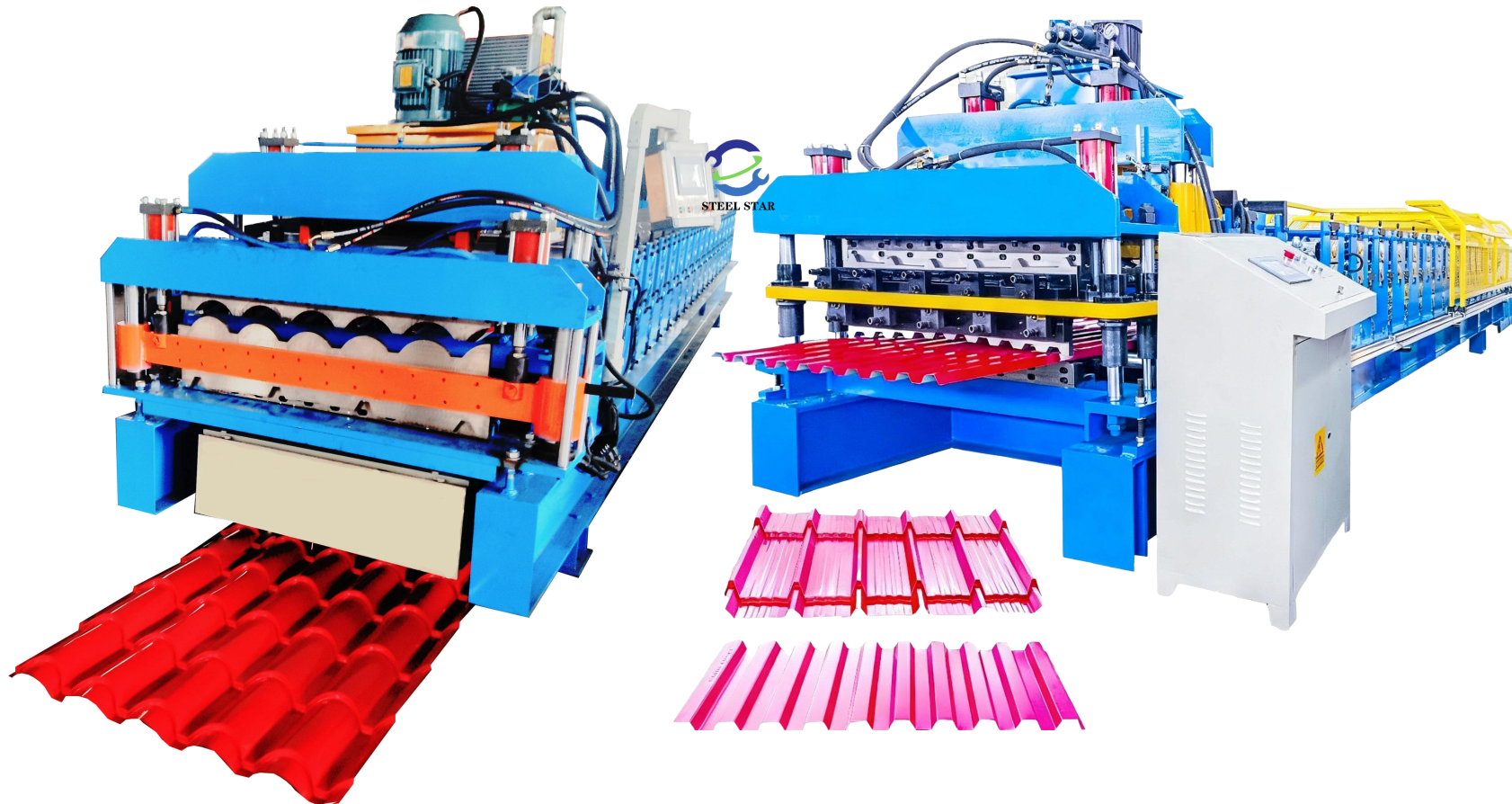



Product Catalog

1. Roof Sheet Roll Forming Machine

STEEL STAR
www.greatforming.com

1-6 Three Layer/Three Models Roof Sheet Roll Forming Machine

Application Scenarios





STEEL STAR
www.greatforming.com

Product Catalog

1. Roof Sheet Roll Forming Machine

1-7 Roof Sheet Arching Machine

Application Scenarios



2-1 Light Keel Stud And Track C/U/V/Omega Roll Forming Machine

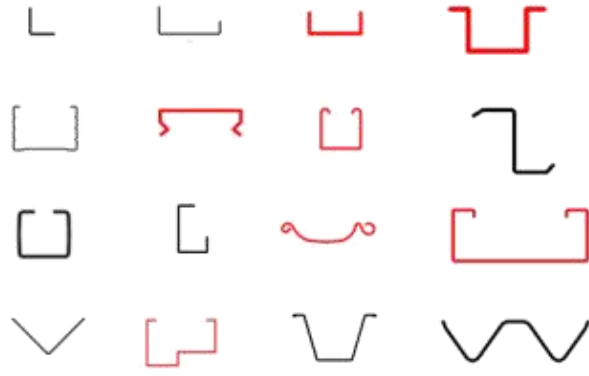
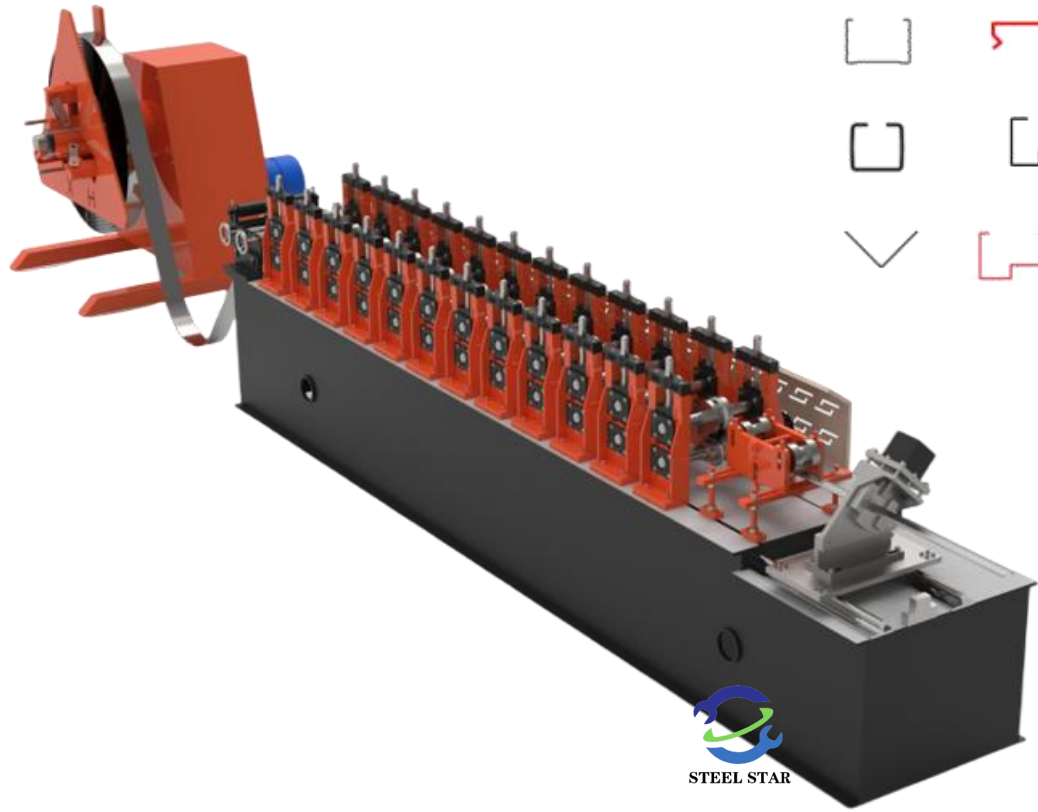

High--speed

20m--150m/min

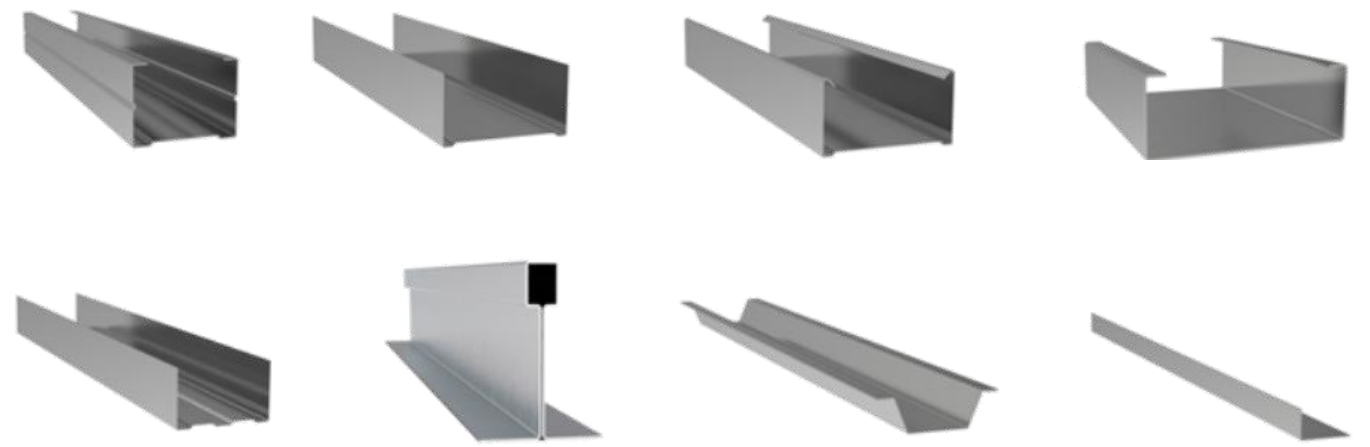

2-1 Light Keel Stud And Track C/U/V/Omega Roll Forming Machine

Application Scenarios

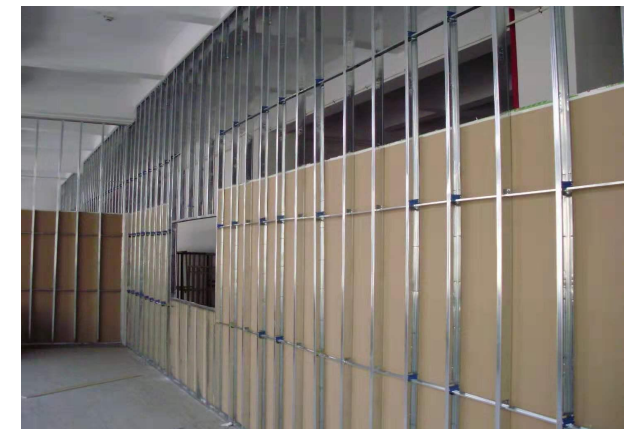



STEEL STAR
www.greatforming.com

High Speed Light Keel Roll Forming Machine

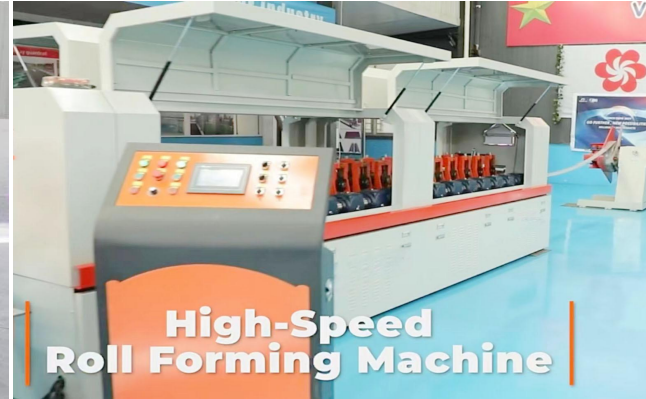

High-Speed Roll Forming Machine

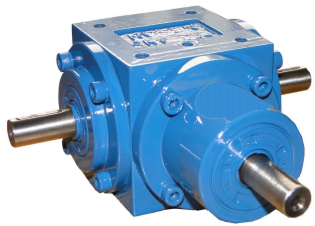

Gear Box Structure

High Speed 50m-150m/min

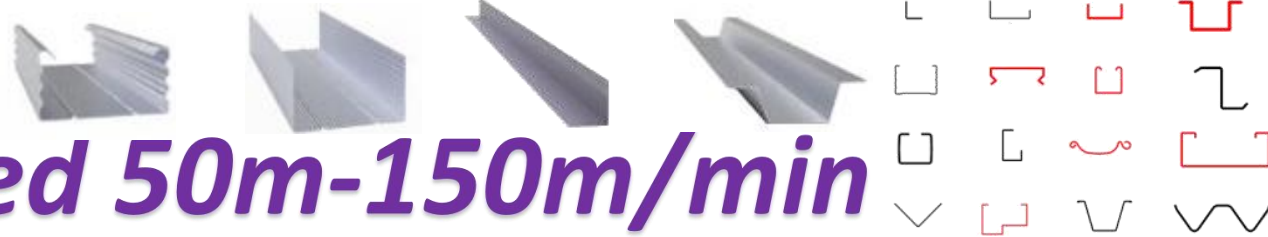

C--Model

U--Model

V--Model

Omega--Model





3-1 Shutter Door Roll Forming Machine

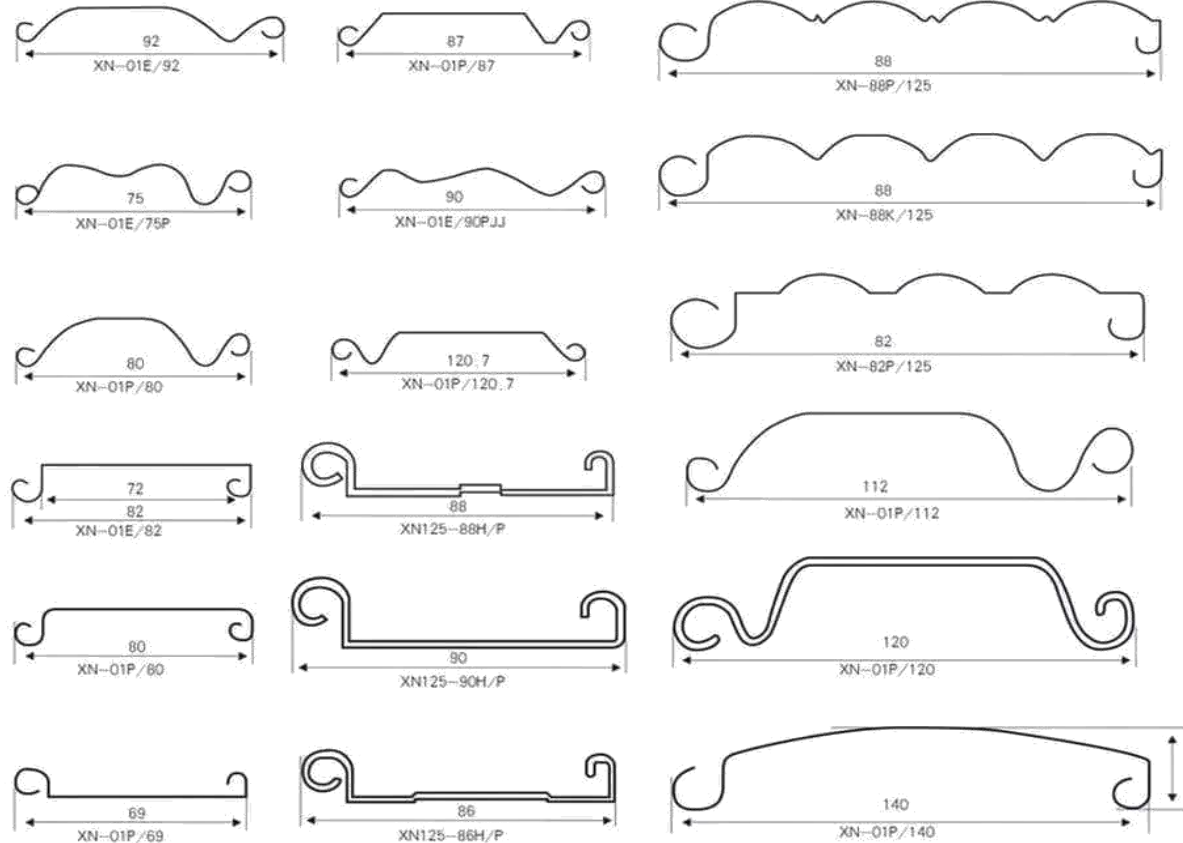
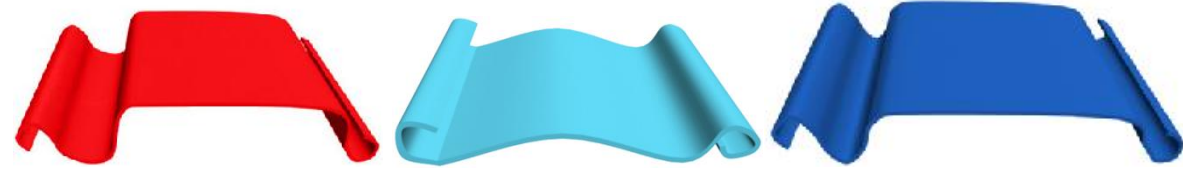
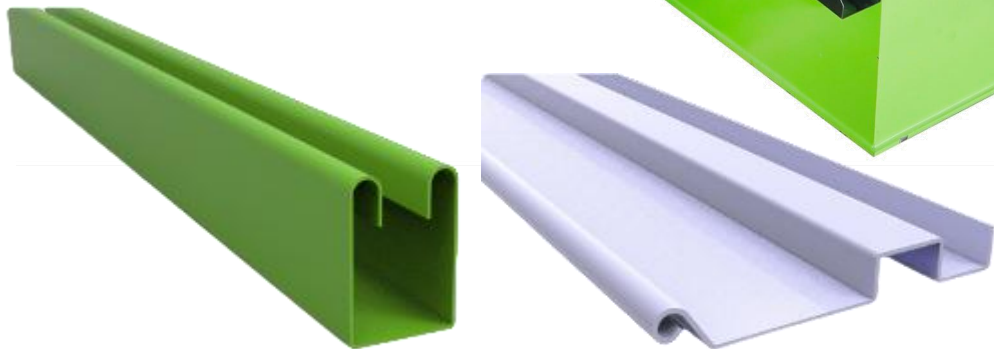
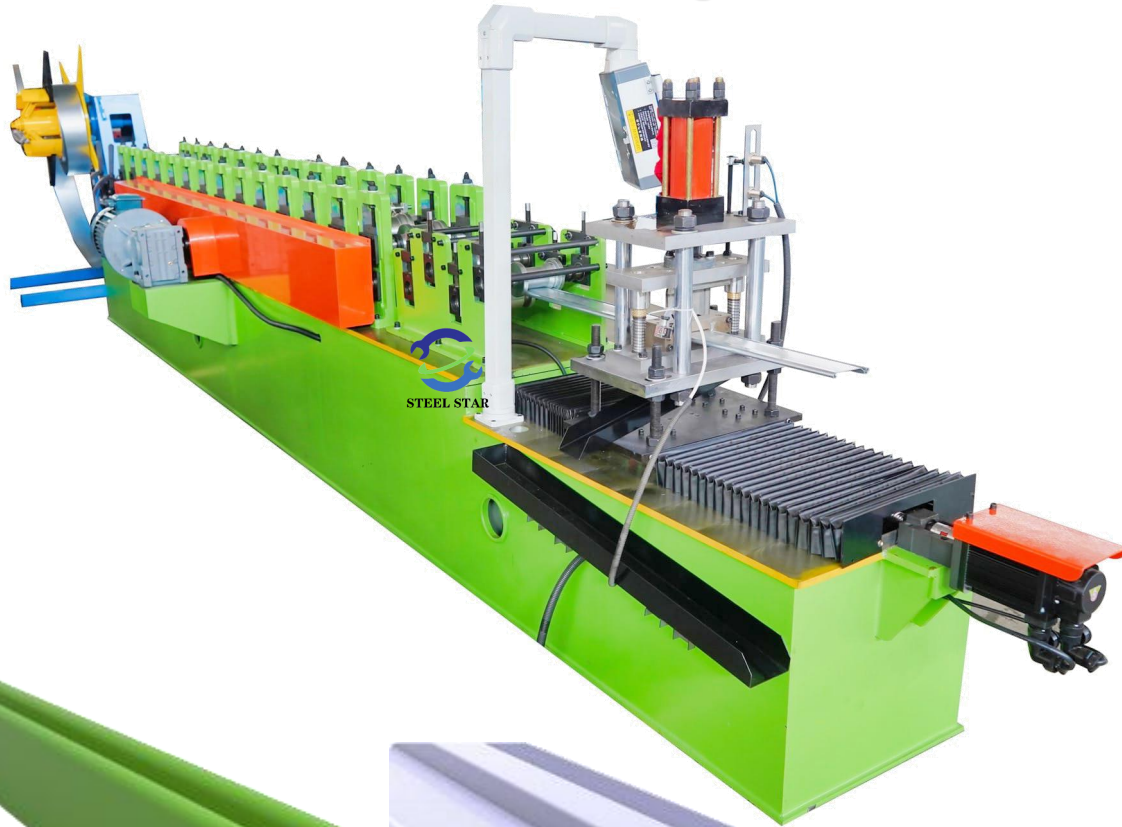



3-1 Shutter Door Roll Forming Machine

Application Scenarios

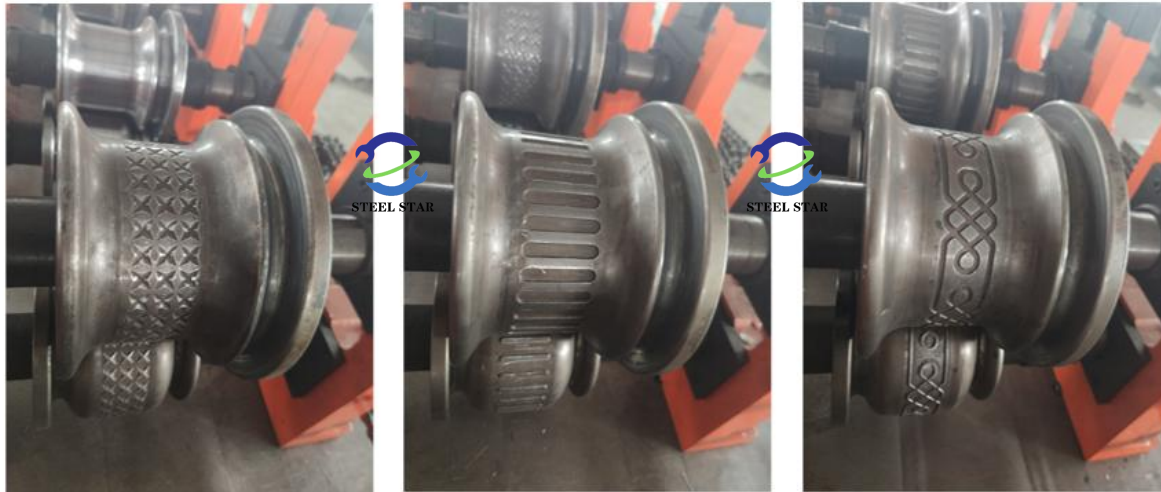



STEEL STAR
www.greatforming.com

Product Catalog

4. C/Z Purlin Roll Forming Machine

4-1 C/Z Purlin Roll Forming Machine

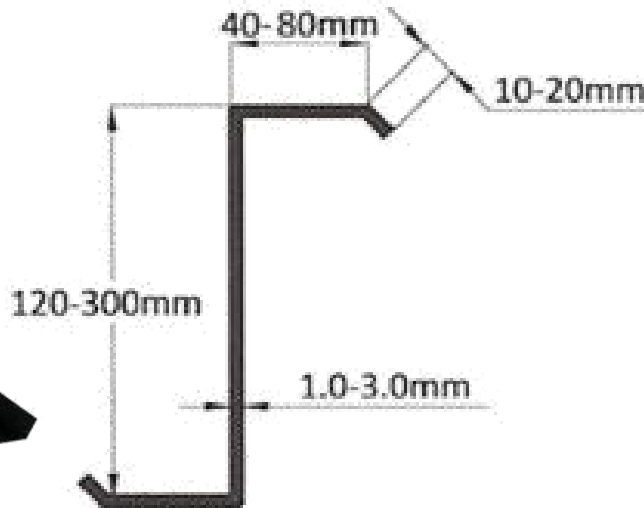
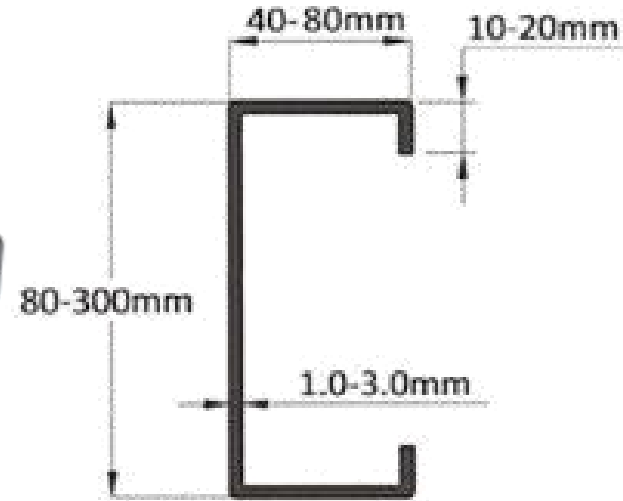
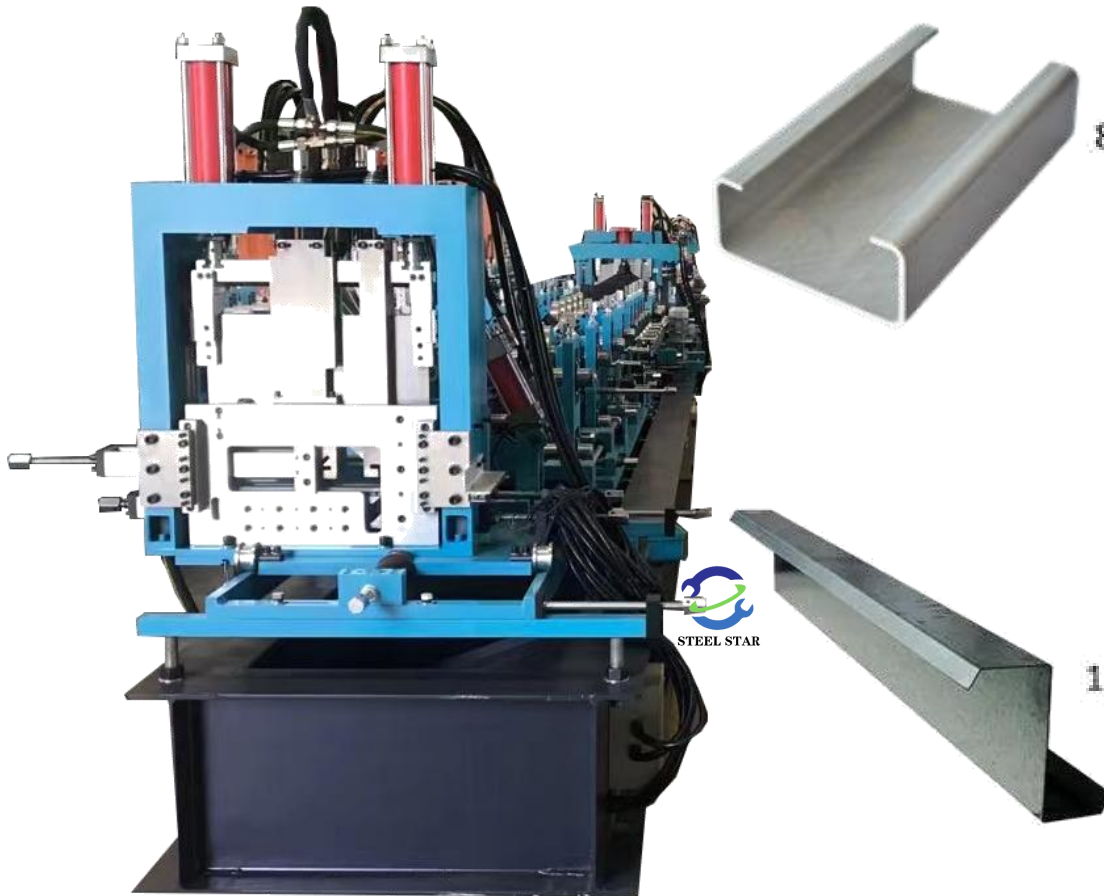

Application Scenarios

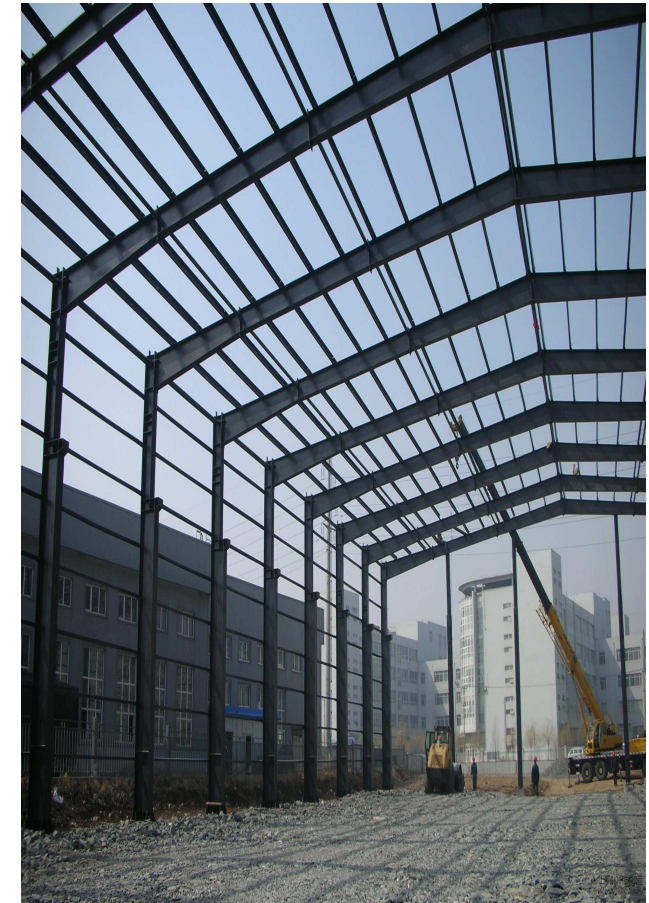



STEEL STAR
www.greatforming.com

Product Catalog

5. Ridge Cap Roll Forming Machine

5-1 Ridge Cap Roll Forming Machine



Application Scenarios

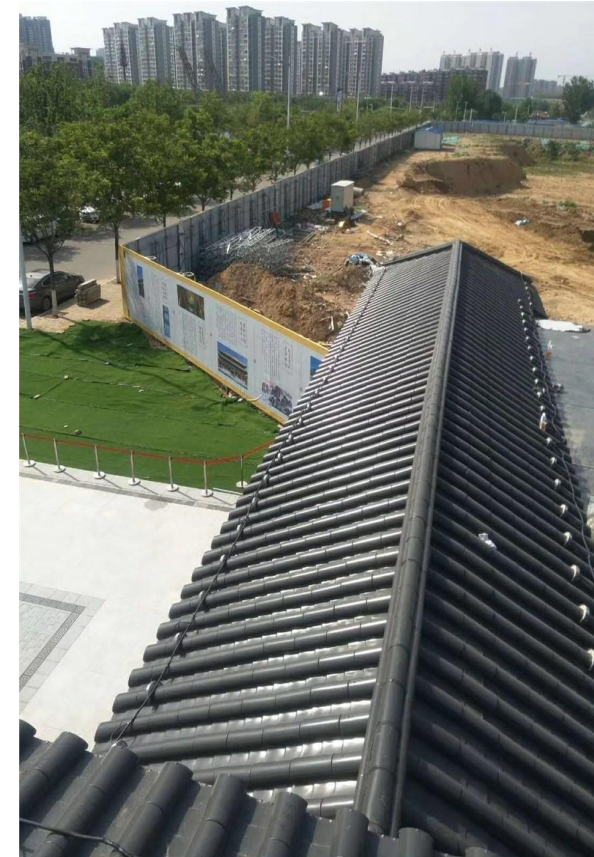

6. Barrel Corrugated Roll Forming Machine

6-1 Barrel Corrugated Roll Forming Machine

Application Scenarios

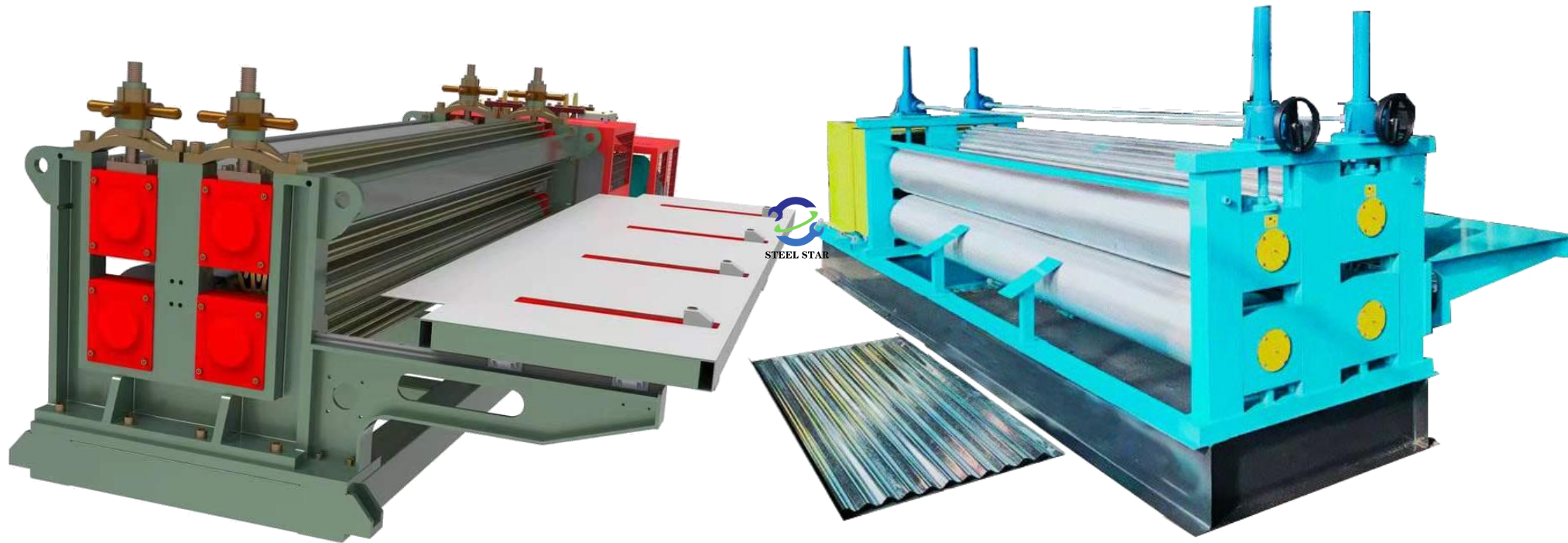



STEEL STAR
www.greatforming.com

Product Catalog

7. Floor Deck Roll Forming Machine

7-1 Floor Deck Roll Forming Machine

Application Scenarios





STEEL STAR
www.greatforming.com

Product Catalog

8. Car Board Roll Forming Machine

8-1 Car Board Roll Forming Machine

Application Scenarios

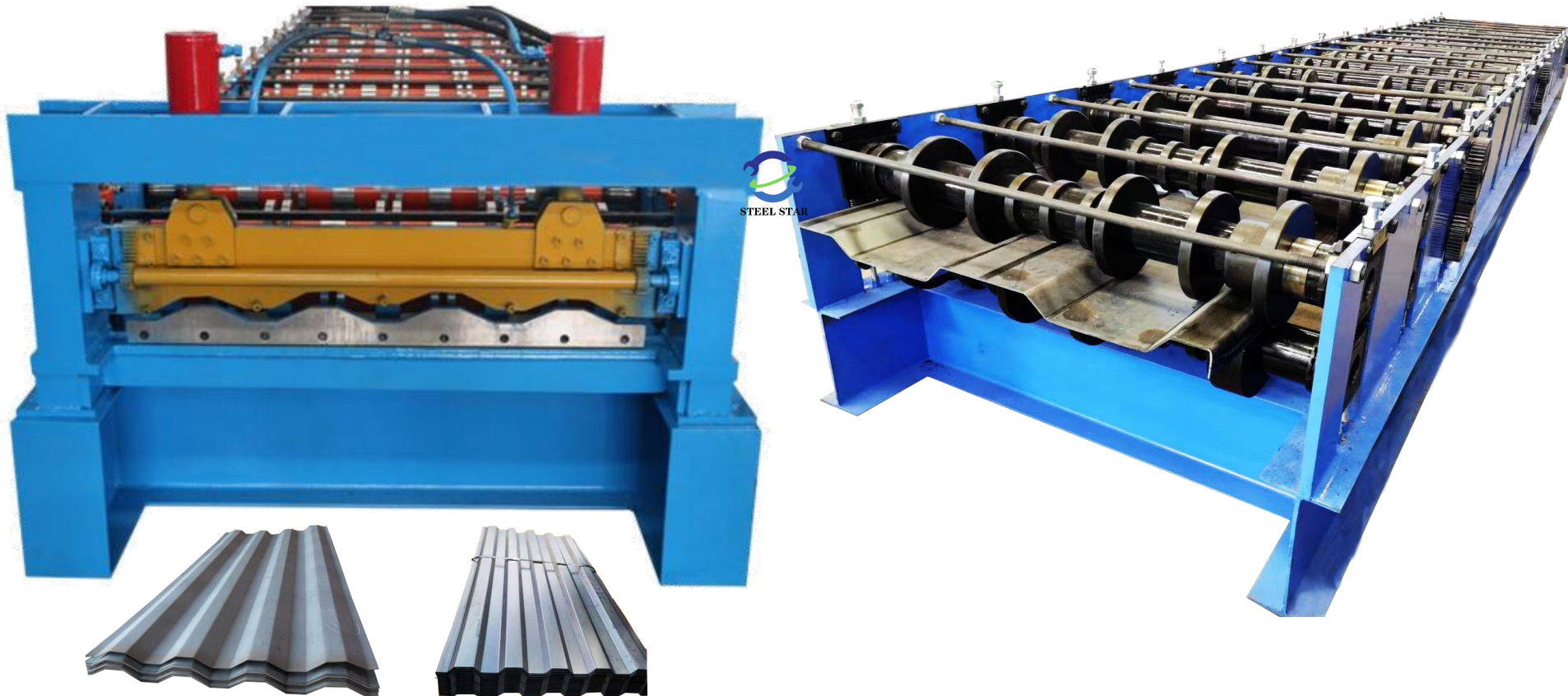



STEEL STAR
www.greatforming.com

Product Catalog

9. Rain Gutter / Downspouts Roll Forming Machine

9-1 Rain Gutter / Downspouts Roll Forming Machine

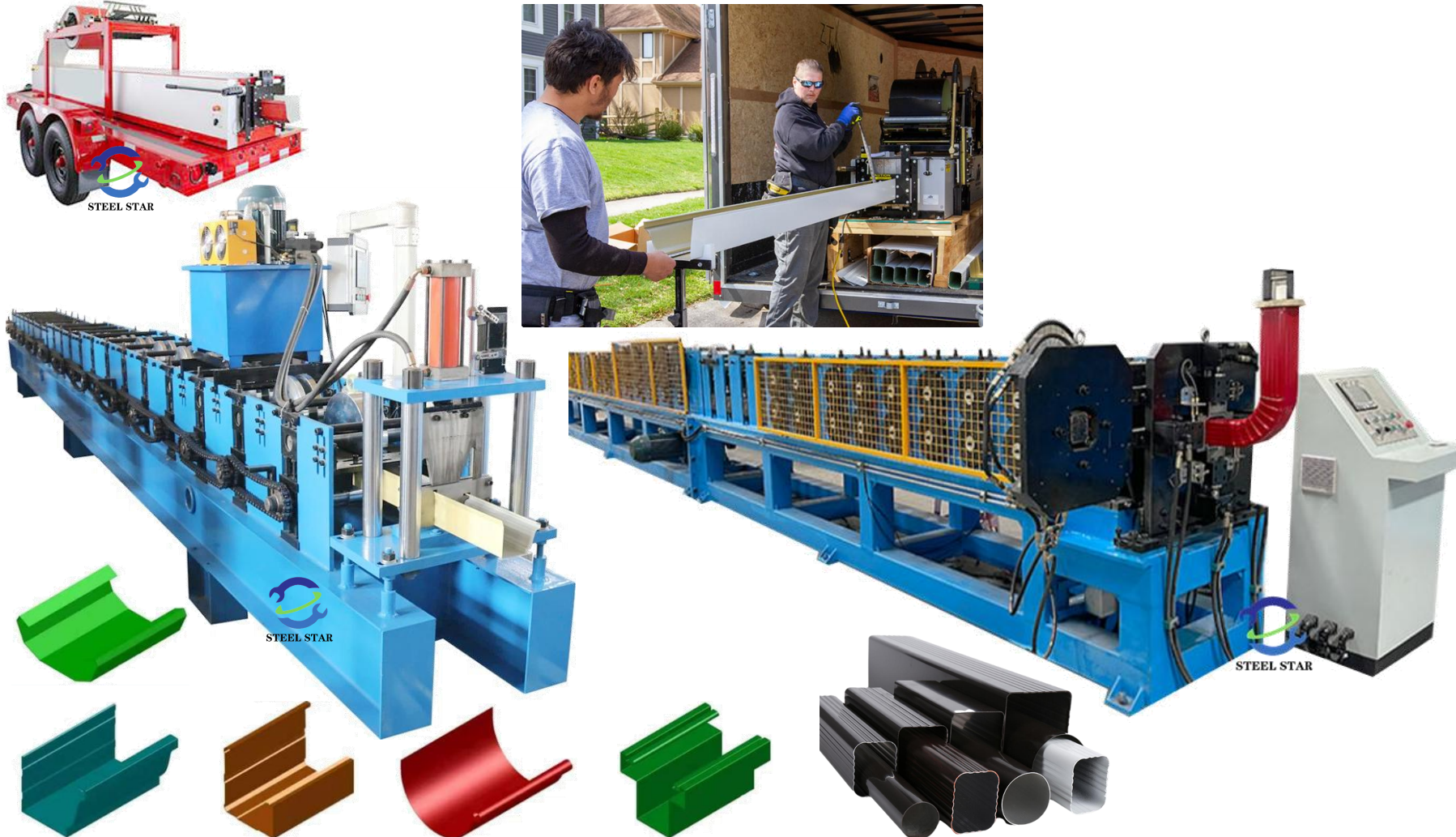

Application Scenarios





STEEL STAR
www.greatforming.com

Product Catalog

10. Light Keel Villa Frame Roll Forming Machine

10-1 Light Keel Villa Frame Roll Forming Machine

Application Scenarios

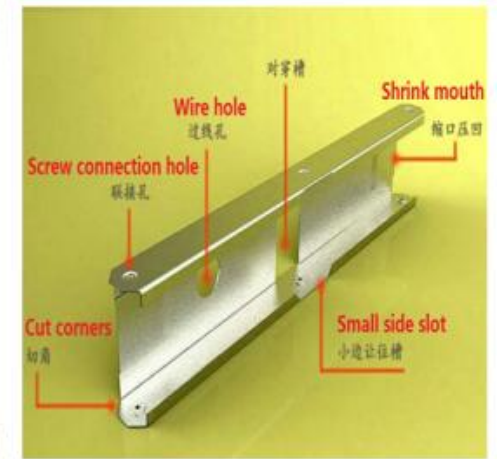
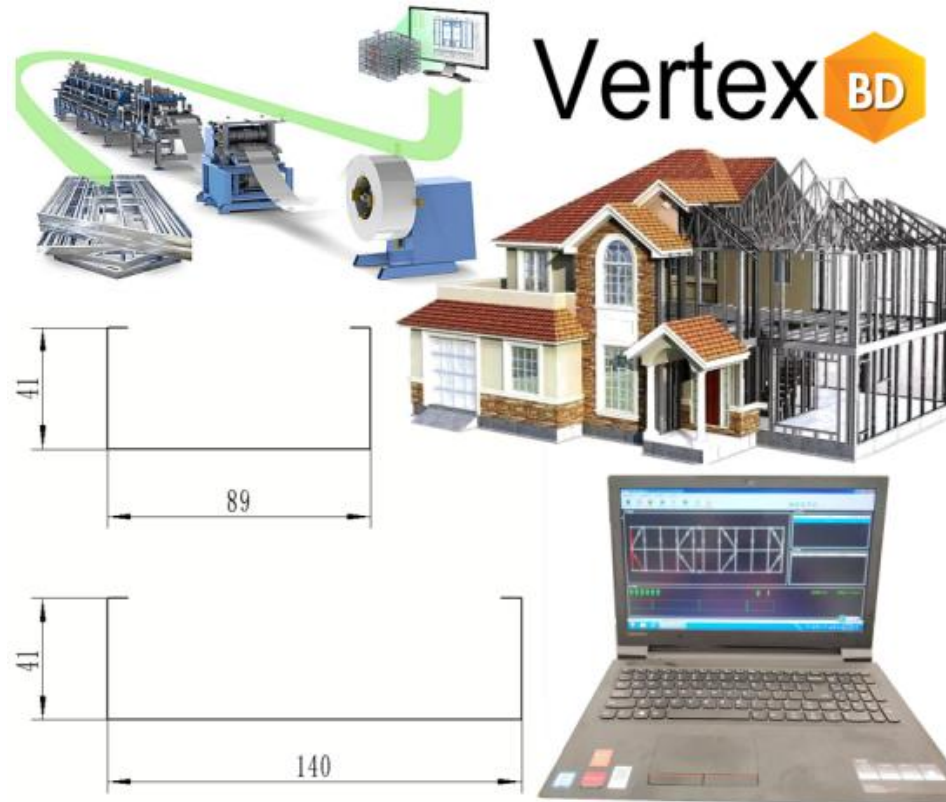



STEEL STAR
www.greatforming.com

Product Catalog

11. Guardrail Plate Roll Forming Machine

11-1 Guardrail Plate Roll Forming Machine

Application Scenarios

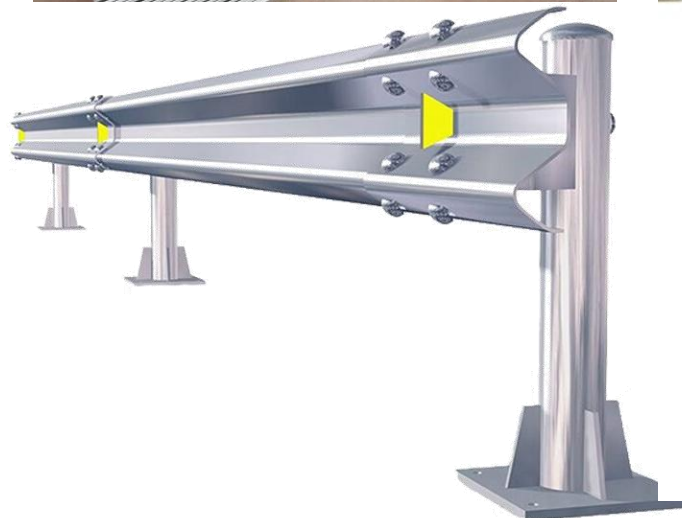
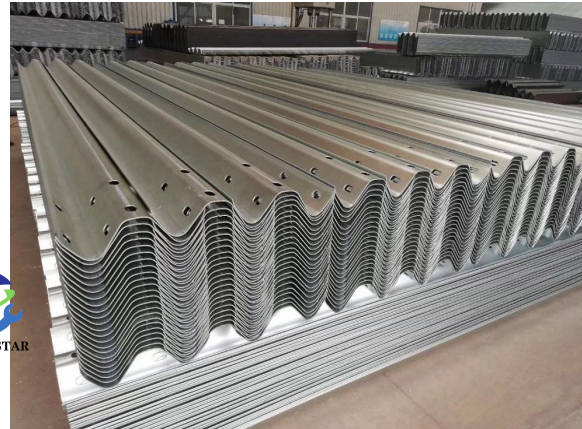



STEEL STAR
www.greatforming.com

Product Catalog

12. EPS Foam/Rock Wool Roof Sheet Composite Production Line

12-1 EPS Foam/Rock Wool Roof Sheet Composite Production Line

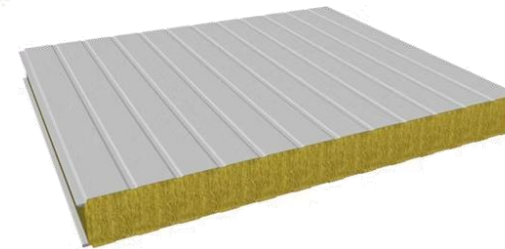
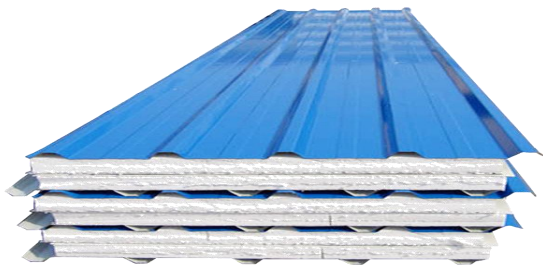

Application Scenarios





STEEL STAR
www.greatforming.com

Product Catalog

13. (PU) Polyurethane Sandwich Panel Production Line

Sandwich Panel

13-1 (PU) Polyurethane Sandwich Panel Production Line

Application Scenarios

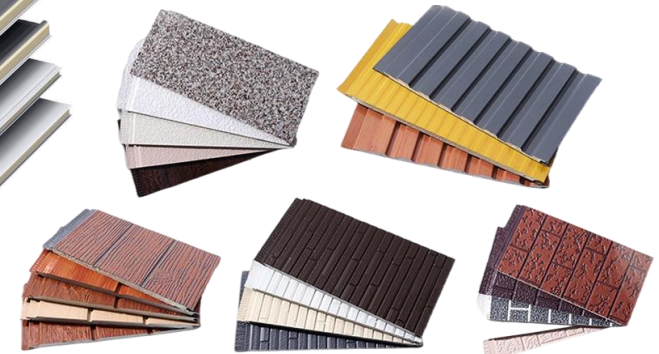
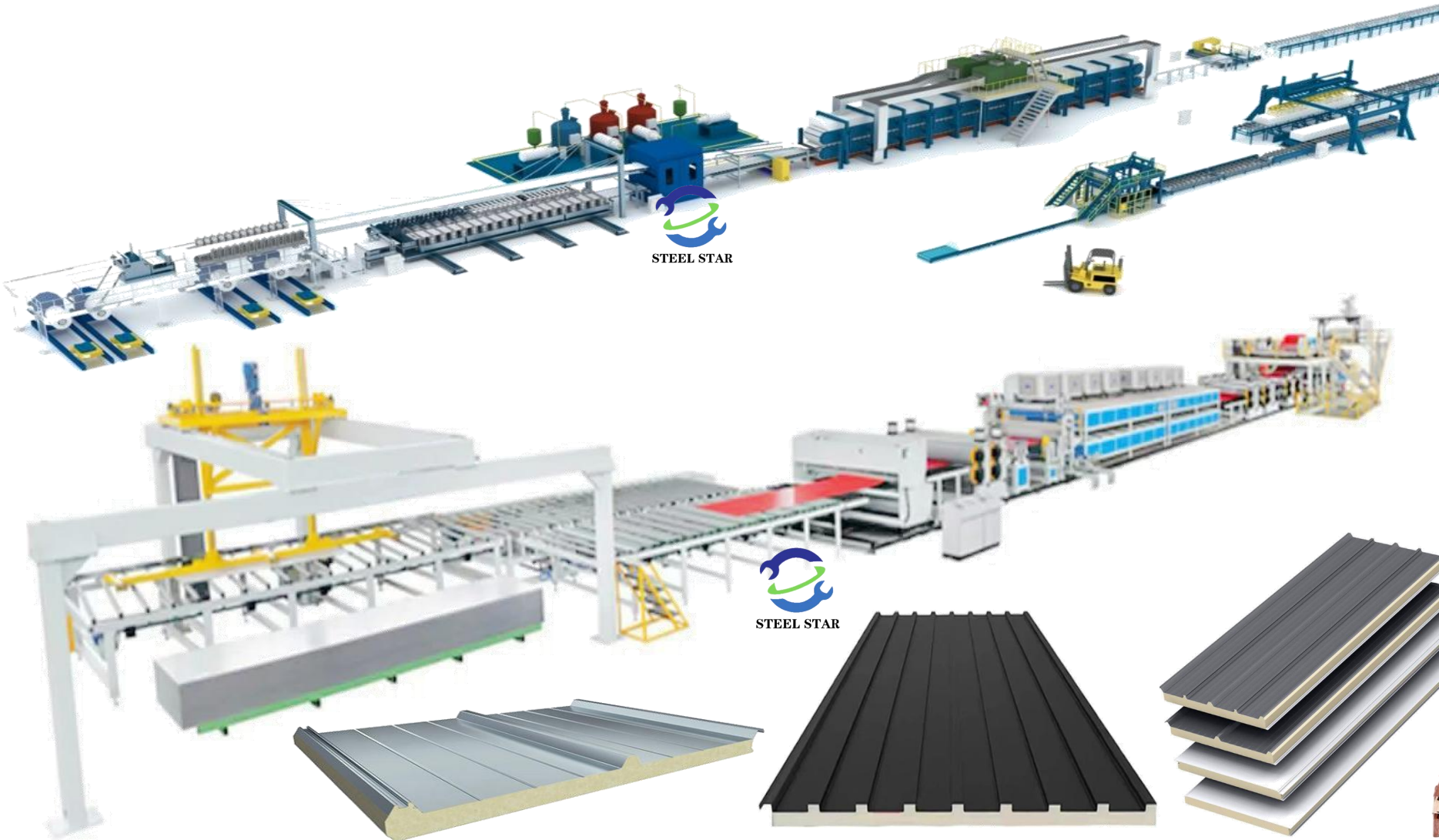



STEEL STAR
www.greatforming.com

Product Catalog

14. Decoiler / Auto Stacker Roof Panel Machine

14-1 Decoiler / Auto Stacker Roof Panel Machine Roll Forming Machine

Application Scenarios



15-1 Bending Machine/ Guillotine Shearing Machine

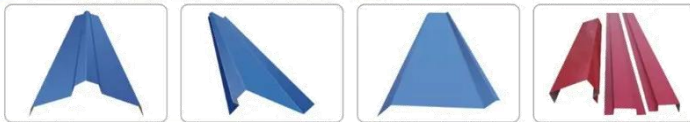



STEEL STAR
www.greatforming.com

Product Catalog

16. Steel Coil Slitting Line Machine

16-1 Steel Coil Slitting Line Machine



Application Scenarios

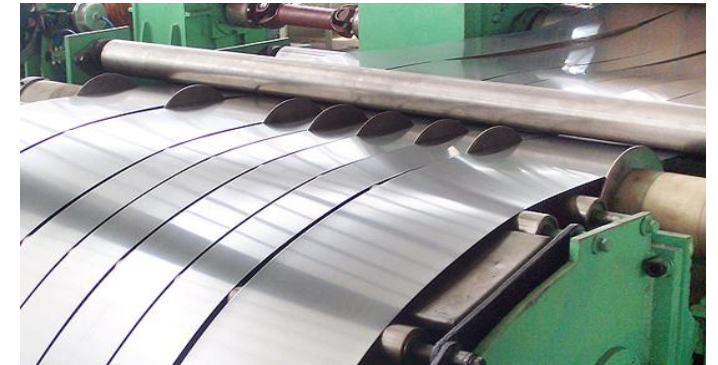



STEEL STAR
www.greatforming.com

Product Catalog

17. Solar Bracket Machine

17-1 Solar Bracket Machine



Application Scenarios





STEEL STAR
www.greatforming.com

Product Catalog

18. Steel Pipe Making Machine

18-1 Steel Pipe Making Machine



Application Scenarios

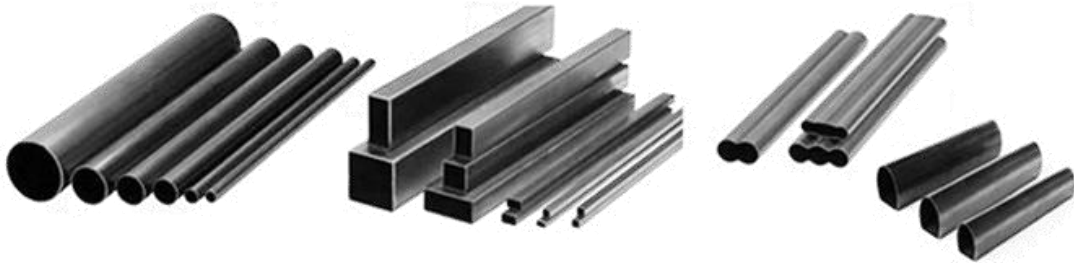



STEEL STAR
www.greatforming.com

Product Catalog

19. Racking Roll Forming Machine

19-1 Racking Roll Forming Machine

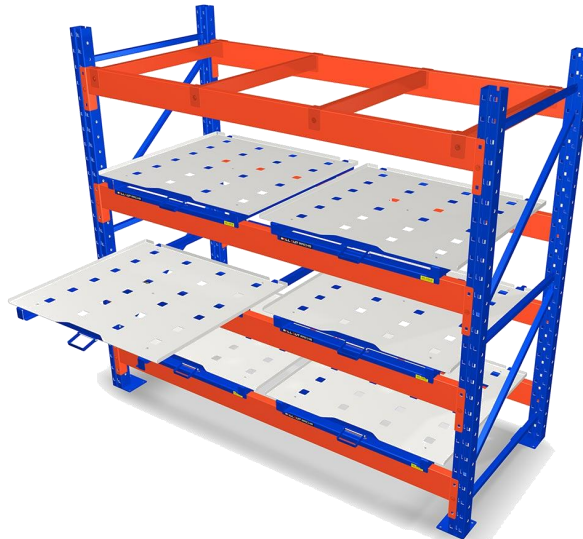
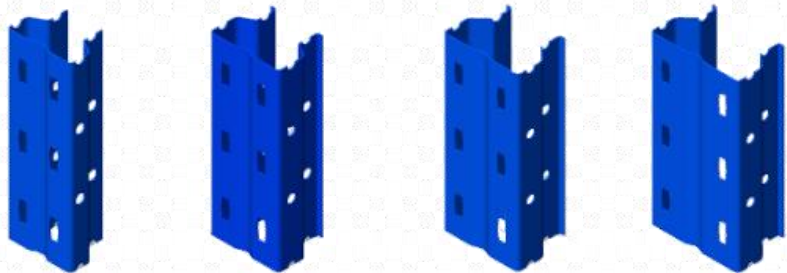
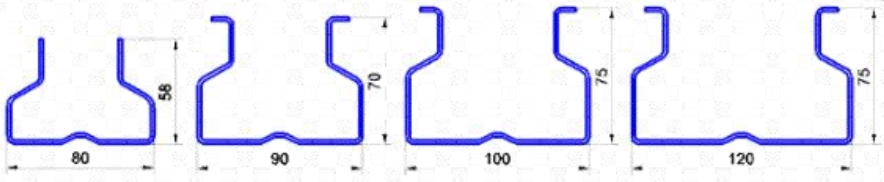

Application Scenarios





STEEL STAR
www.greatforming.com

Product Catalog

20. Cable Tray Roll Forming Machine

20-1 Cable Tray Roll Forming Machine

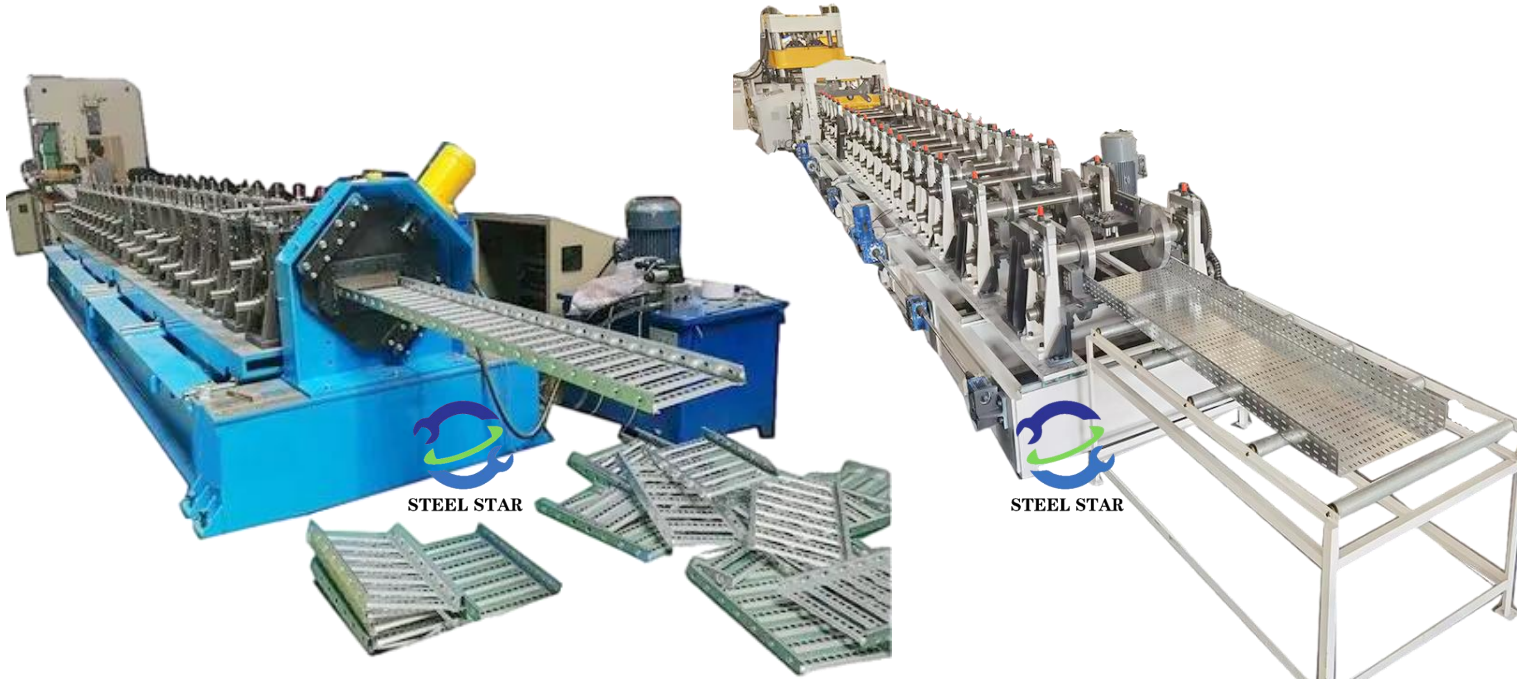

Application Scenarios

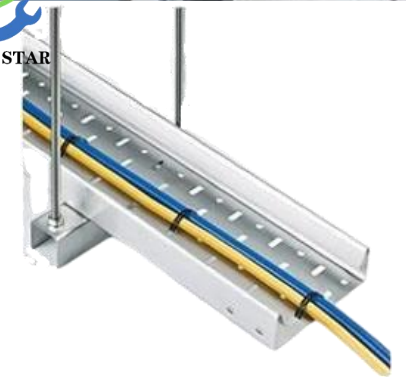



STEEL STAR
www.greatforming.com

Product Catalog

21. Metal Embossing Line

21-1 Metal Embossing Line



Application Scenarios

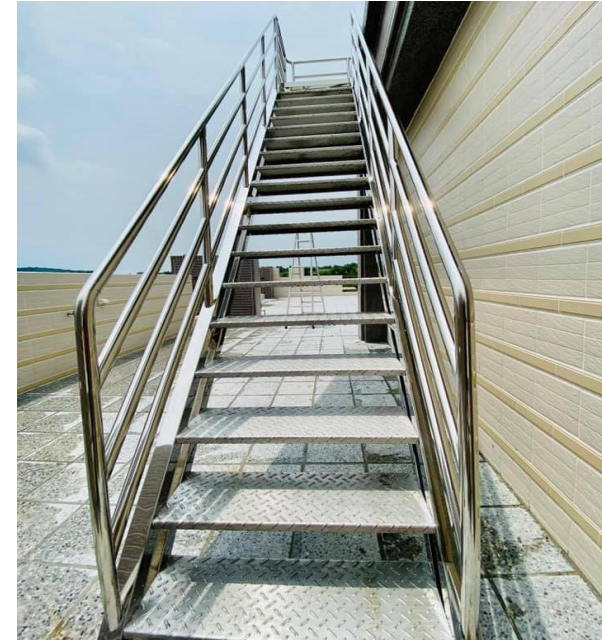



STEEL STAR
www.greatforming.com

Product Catalog

22. Fence Post / Picket Fence Roll Forming Machine

22-1 Fence Post / Picket Fence Roll Forming Machine

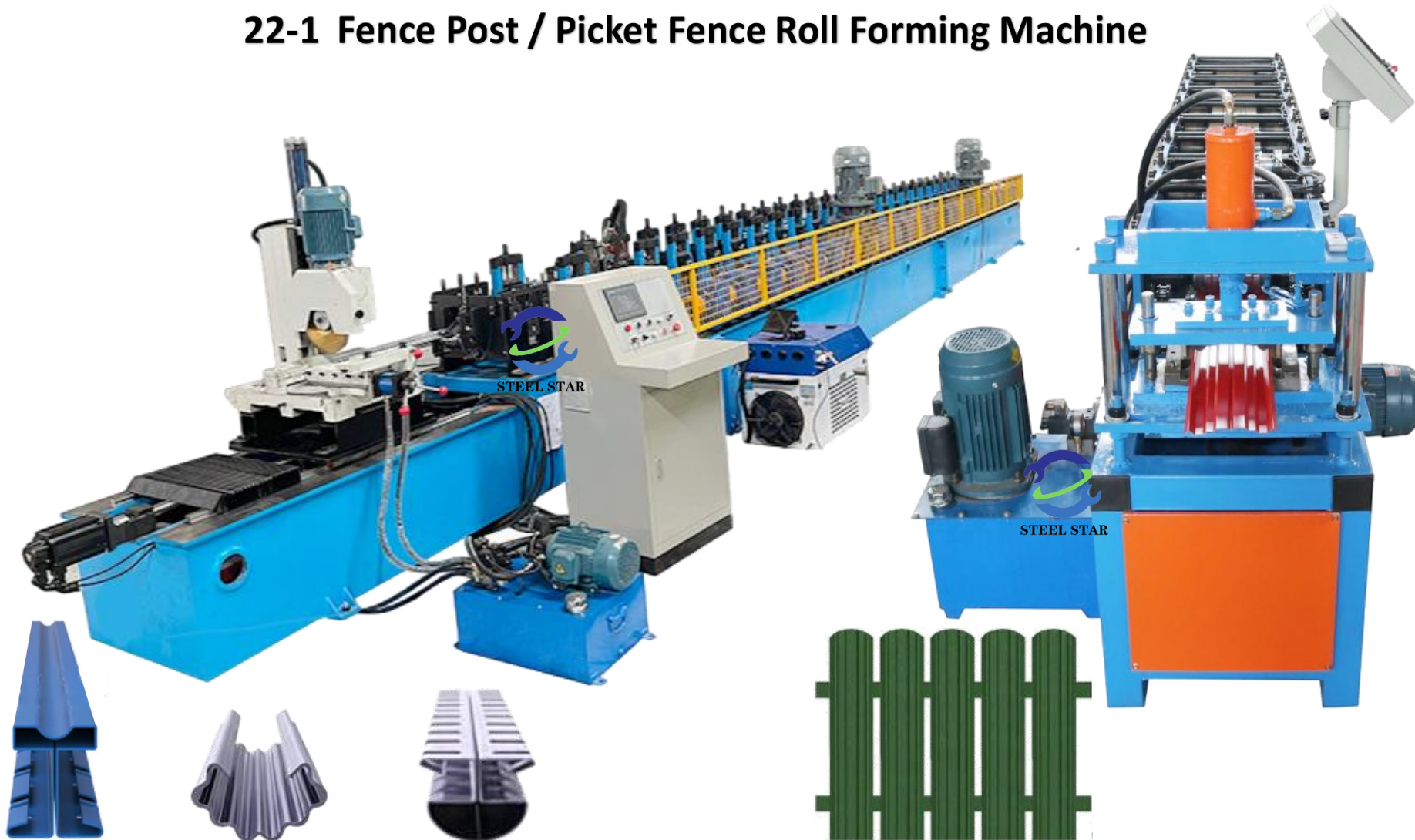

Application Scenarios





STEEL STAR
www.greatforming.com

Product Catalog

23. Silo Roll Forming Machine

23-1 Silo Roll Forming Machine

Application Scenarios

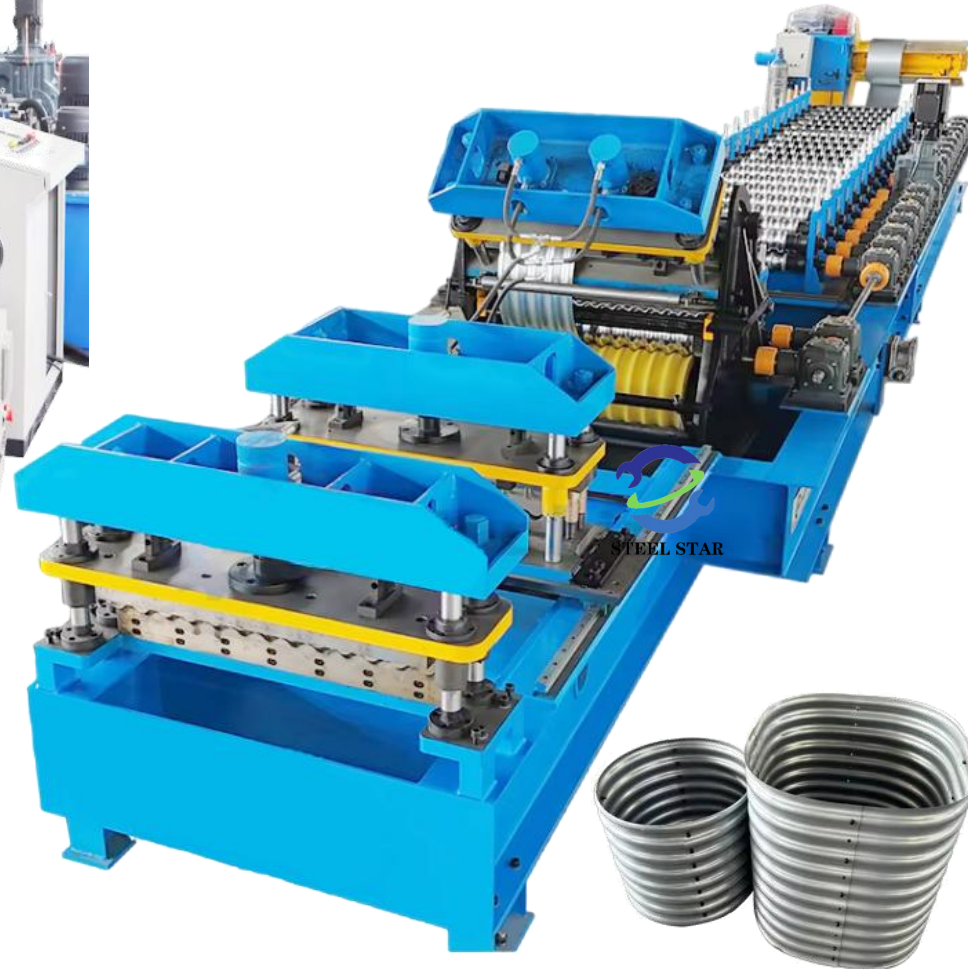
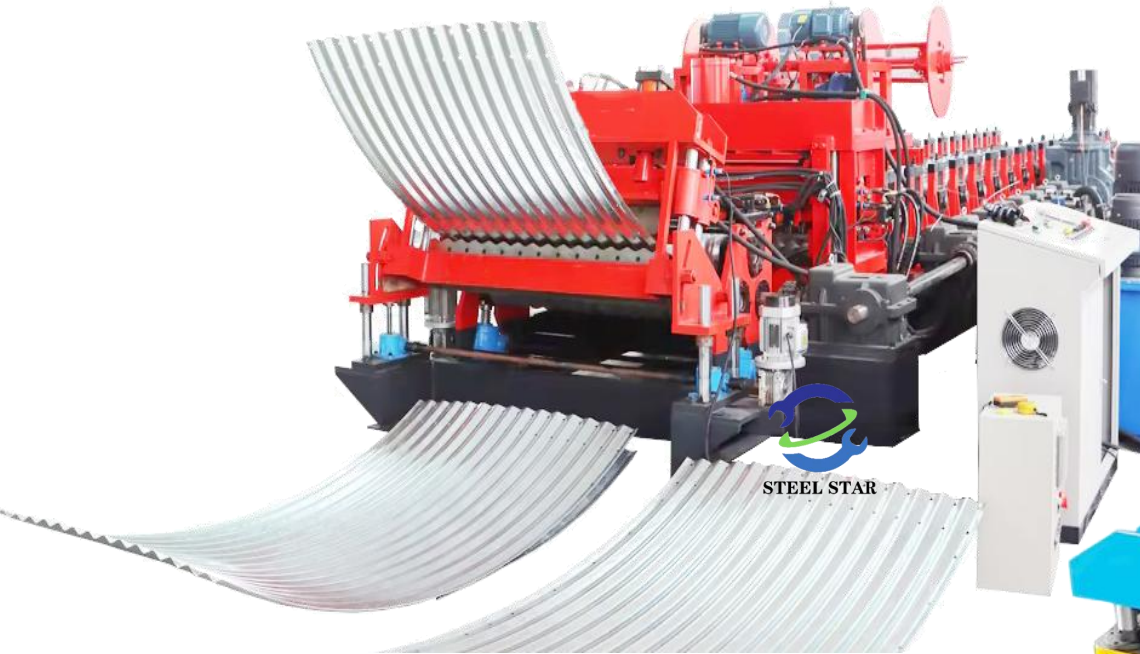



STEEL STAR
www.greatforming.com

Product Catalog

24 Foot Pedal Roll Forming Machine

24-1 Foot Pedal Roll Forming Machine

Application Scenarios





STEEL STAR
www.greatforming.com

Product Catalog

25. Standing Seam Roll Forming Machine

25-1 Standing Seam Roll Forming Machine

Application Scenarios

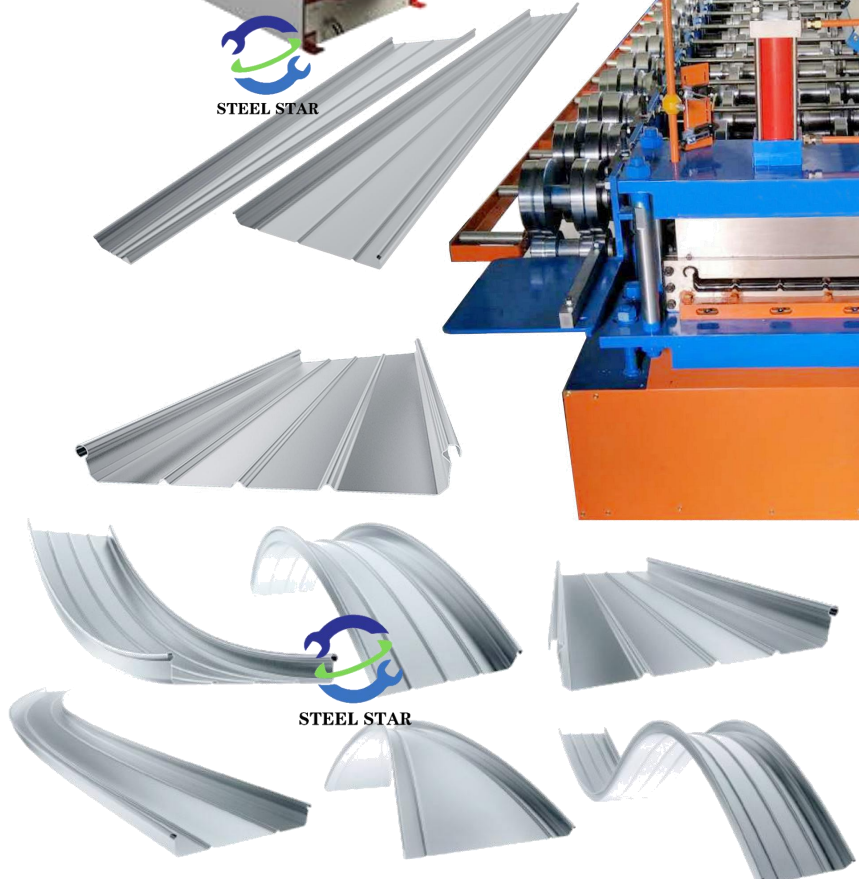
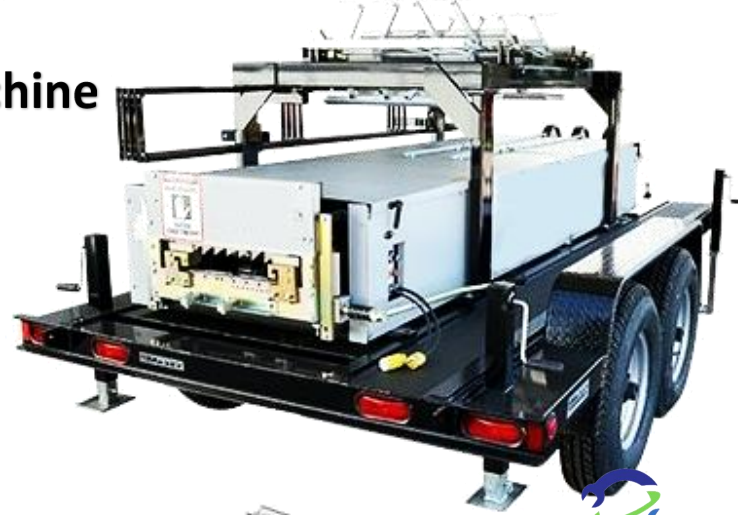
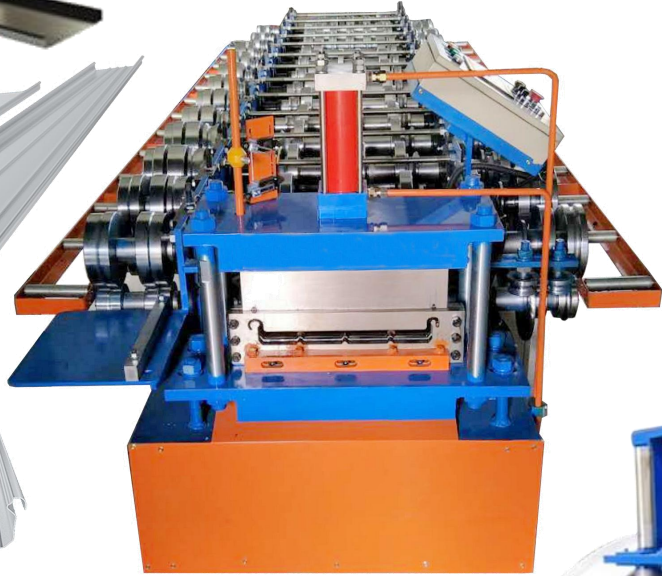



STEEL STAR
www.greatforming.com

Product Catalog

26. Stone Coated Roof Tile Making Machine

26-1 Stone Coated Roof Tile Making Machine

Application Scenarios

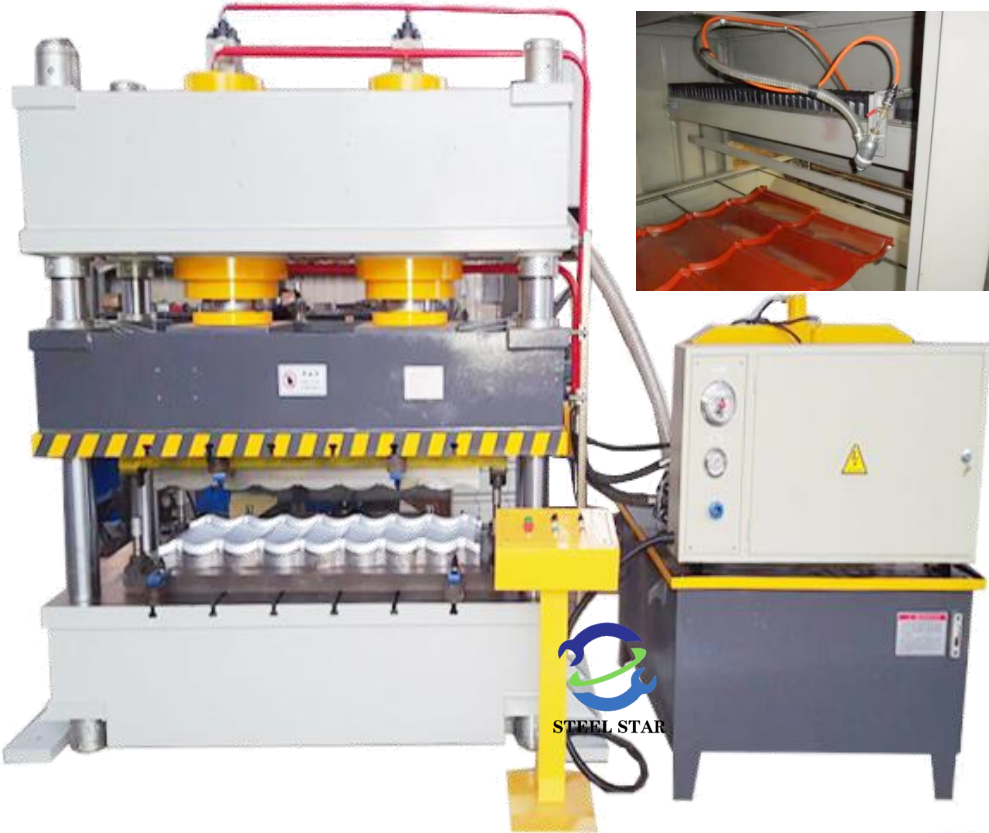

Sprayed
Stone
Coated

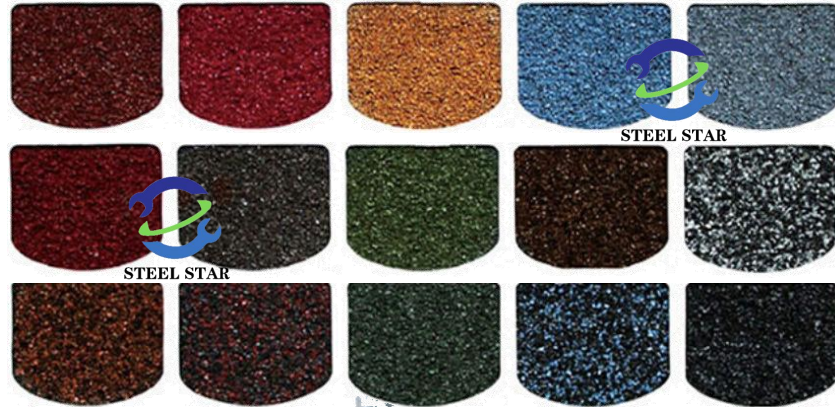

27-1 Various Products Can Be Customized

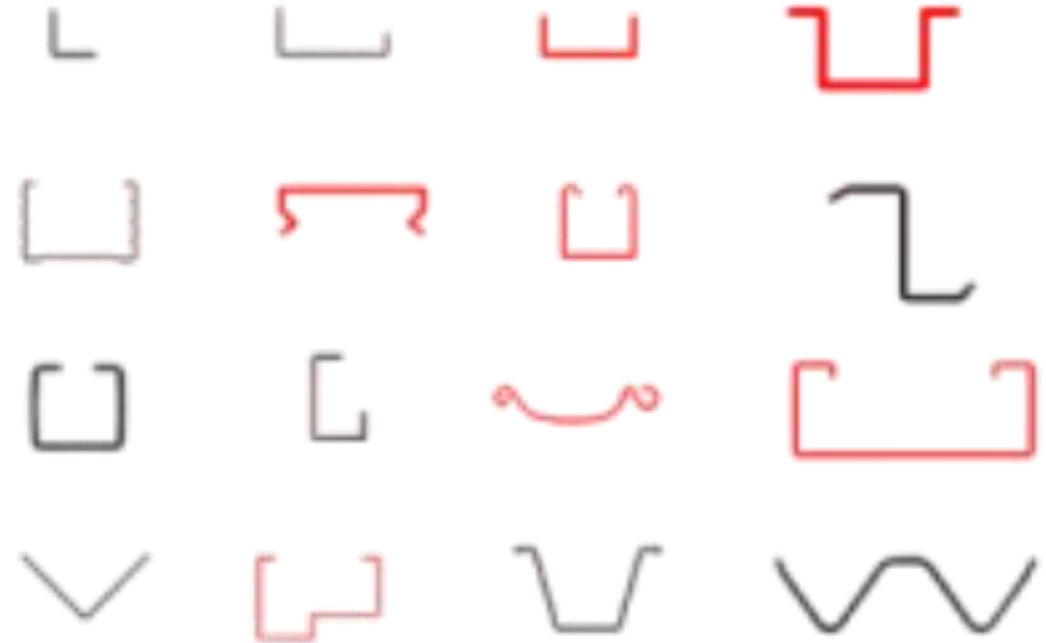
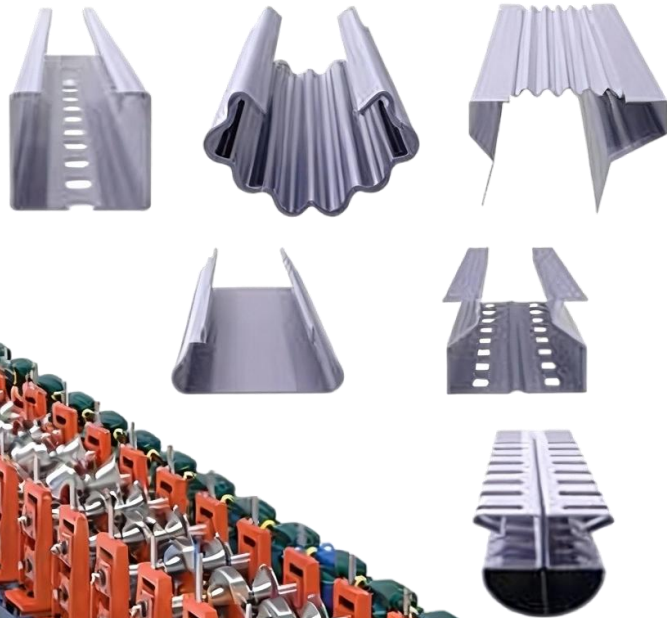
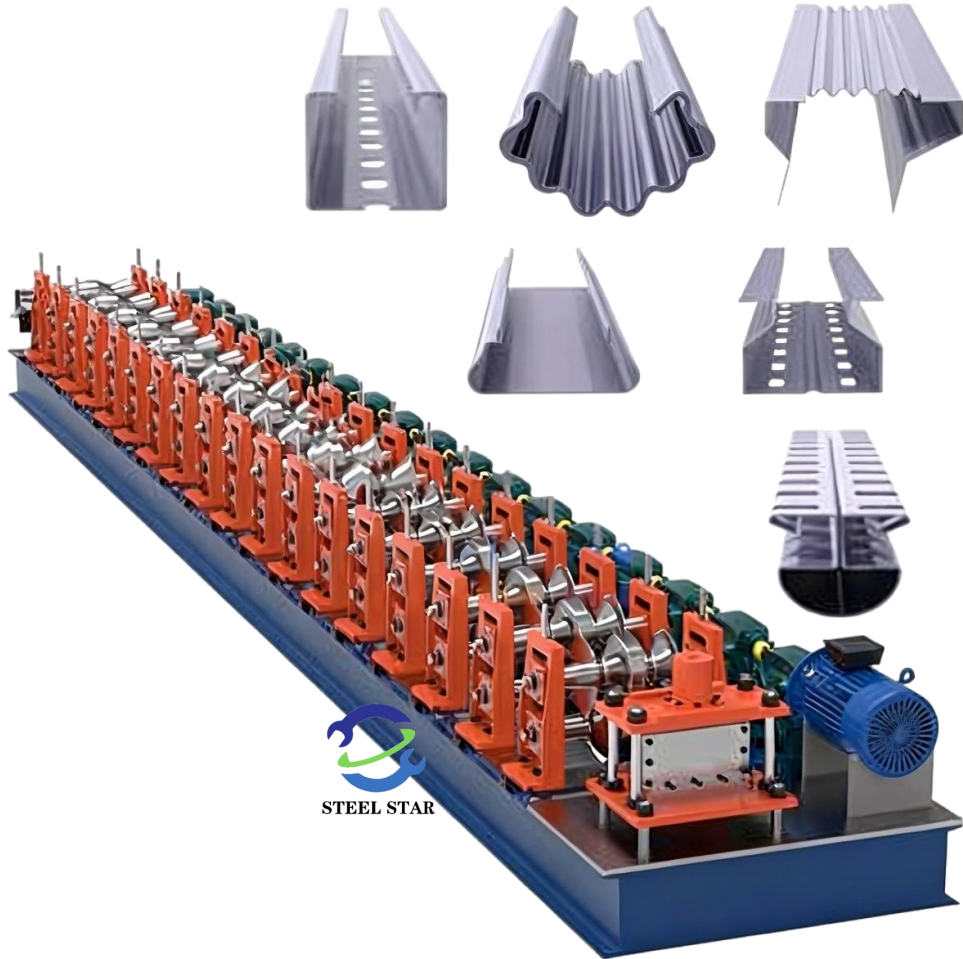



STEEL STAR
www.greatforming.com

Shipping Abroad



STEEL STAR



STEEL STAR
www.greatforming.com

Service



Our customer service will help you solve any problems related to the system: our service is available 24 hours a day during working days. We will answer your questions quickly and reliably.

If necessary, we will send professional debugging and installation equipment personnel who can go to your city and help you install the equipment on site.





STEEL STAR
www.greatforming.com

Contact Us



+86 15075780050

WhatsApp Wechat

(Email) : sam@greatforming.com

Official Website : www.greatforming.com



China



Beijing		1 Hour	
		4 Hour	

Tianjin		0.5 Hour	
		2.5 Hour	

Jinan		1 Hour	
		3 Hour	